

May 20, 2013



**New for 2013!**  
**The RRA LAR-15<sup>®</sup>**  
**R3 Competition Rifle**  
**See Page 14**

**BAN COMPLIANT MODELS**

Please see the note regarding  
Ban Compliant Models on Pg 5

**Custom Firearms, Parts and Accessories**  
**2013 RETAIL CATALOG**

All prices, configurations, specifications and availability are subject to change without notice.



In 1996, brothers Mark and Chuck Larson founded Rock River Arms in an 1,800 square foot shop in Cleveland, Illinois. Mark and Chuck together brought over 40 years of varied experience in the firearms manufacturing industry into their new endeavor. Rock River Arms soon developed a reputation as one of the finest builders of hand fitted custom 1911 pistols, and their NM frames and slides set new industry standards for tight tolerances, fit and finish.

The brothers soon turned their manufacturing expertise and attention to detail into producing custom .223 caliber "AR" style rifles. Their initial focus on tightening up tolerances and improving the fit, finish and reliability of their rifles was rewarded as the Rock River Arms NM A2 Rifle quickly gained popularity among high-power shooters.

Today, operating out of a state-of-the-art 23,000 square foot facility in Colona, Illinois, the company is producing a full line of custom rifles, parts and accessories, all built with the same focus on providing the finest fit, finish and function at a reasonable price.

The quality and reliability of Rock River Arms firearms continues to win new admirers. The U.S. Drug Enforcement Agency (DEA) and Federal Bureau of Investigation (FBI) put a variety of different manufacturer's rifles through an exhaustive trials process, and based on those trials awarded Rock River Arms with a 5 year contract as their primary supplier. Since that time Rock River Arms has received additional federal contracts.

Rock River Arms remains committed to continuing to provide it's civilian, law enforcement and military customers with the kind of custom products and services on which it's reputation has been built.

## RRA Warranty Information

Rock River Arms offers the following warranties on its products: Complete LAR Rifles, LAR Pistols, LAR-PDS™ Pistols/Carbines, Upper Halves, and Lower Halves carry a Limited Lifetime Warranty against failure of factory parts and labor. If you have any questions concerning the warranty on your Rock River Arms rifle, pistol, upper half or lower half, please call Rock River Arms for clarification.

## RRA Order/Return Information

Once submitted, all orders are final. Changes requested after order submission, including configuration, subs, etc., will result in a reprocessing charge. Complete rifles shown with standard accessory package. Please see our website for current Lead Time and Delivery Estimates.

**RETURNS:** All returned and/or refused products are subject to a 20% restocking fee. The restocking fee will not apply if the return is the result of an error by Rock River Arms. Shipping fees are not refundable. All returns must be preapproved by RRA, must be issued a return authorization (RMA), and must be returned in new condition within 30 days of order fulfillment. Please contact RRA Sales/Customer Service toll free at 866-980-7625 for any additional information and/or return authorization. All orders must comply with all applicable Federal, State and Local laws.

**All prices, configurations and specifications are subject to change without notice.**

## RRA Rifle/Upper Half Identification

We are now laser engraving Rock River Arms Inc. on all of our upper receivers.

All of our factory-built complete upper halves and complete rifles are engraved with Rock River Arms' trademarked logo.

Since 2010, most RRA barrels are caliber and twist rate marked on the forward portion of the barrel.



**Rock River Arms, Inc.** • 1042 Cleveland Road, Colona, IL 61241

Toll Free: 866-980-ROCK (7625) • Tel: 309-792-5780, Fax: 309-792-5781 • Email: [info@rockriverarms.com](mailto:info@rockriverarms.com)

Visit [www.rockriverarms.com](http://www.rockriverarms.com) for the latest product information and Secure Online Ordering!





**RRA Options and Upgrades** for Complete Rifles, Upper Halves, Lower Halves 4 / 5

- **RRA LAR-47®** 7.62x39mm Rifles 6
- **RRA LAR-15LH®** 5.56/.223 Caliber LEF-T® Rifles and Upper Halves 7 / 13
- **RRA LAR-15®** 5.56/.223 Caliber Rifles, Pistols and Upper Halves 14 / 35
- **RRA LAR-PDS®** 5.56/.223 Caliber Piston Driven Pistols and Carbines 36 / 39
- **RRA LAR-8®** .308 Caliber Rifles, Upper Halves, Lower and Parts 40 / 50
- **RRA LAR-6.8®** 6.8mm SPC Rifles, Upper Halves and Lower 51 / 53
- **RRA LAR-458®** .458 SOCOM Rifles, Upper Halves and Lower 54 / 56
- **RRA LAR-9®** 9mm Rifles, Pistols, Upper Halves, Lower and Parts 57 / 61
- **RRA LAR-40®** .40 S&W Rifles and Upper Halves 62 / 63

**Barrel Assemblies and Parts** 64 / 65

**Magazines, Mag Pouches** 76 / 77

**Upper Receivers and Parts** 66 / 67

**Gun Cleaning, Gun Cases** 77 / 78

**Front and Rear Sight Assemblies** 68 / 69

**Scope Mounts, Bases** 78

**Lower Receivers and Parts** 69 / 71

**EOTech HOLOSights** 79

**Buttstock, Pistol Grips** 72 / 73

**Slings, Sling Adapters** 79

**Handguards, Quad Rails** 74 / 75

**RRA Logo Gear** 80 / 81

**RRA Law Enforcement and Government Sales** 82 / 86

- **RRA 1911 POLY** .45 ACP 1911 Pistol 87



## RRA Quad Rail Free Float Mid-Length Handguard HANDGUARD OPTIONS

### SUBSTITUTE FOR CAR OR R4 - CAR LENGTH GAS SYSTEM:

Substitute R-4 Handguard for CAR Handguard	<b>Add \$7</b>
Substitute RRA Aluminum Free Float Tube	<b>Add \$65</b>
Substitute Hogue Free Float Tube	<b>Add \$100</b>
Substitute RRA Delta Quad Rail CAR Drop-In	<b>Add \$120</b>
Substitute RRA Quad Rail with 3 Rail Covers - Pistol Length	<b>Add \$130</b>
Substitute RRA Quad Rail Free Float with 3 Rail Covers	<b>Add \$145</b>
Substitute RRA Wraparound Half Quad with 3 Rail Covers	<b>Add \$160</b>

### SUBSTITUTE FOR MID-LENGTH - MID-LENGTH GAS SYSTEM:

Substitute RRA Aluminum Free Float Tube	<b>Add \$65</b>
Substitute RRA Delta Quad Rail Mid Drop-In	<b>Add \$120</b>
Substitute RRA Quad Rail Free Float with 3 Rail Covers	<b>Add \$155</b>
Substitute RRA Half Quad with 3 Rail Covers	<b>Add \$165</b>
Substitute RRA Advanced Half Quad with 3 Rail Covers	<b>Add \$180</b>
Substitute RRA Wraparound Quad with 3 Rail Covers	<b>Add \$195</b>

### SUBSTITUTE FOR A2 - RIFLE LENGTH GAS SYSTEM:

Substitute RRA Aluminum Free Float Tube	<b>Add \$65</b>
Substitute Hogue Free Float Tube	<b>Add \$125</b>
Substitute RRA Quad Rail Free Float with 3 Rail Covers	<b>Add \$185</b>
Substitute RRA Advanced Half Quad with 3 Rail Covers	<b>Add \$190</b>

### SUBSTITUTE FOR RRA ALUMINUM FREE FLOAT TUBE:

Substitute RRA Quad Rail with 3 Rail Covers - Pistol Length	<b>Add \$75</b>
Substitute RRA Quad Rail with 3 Rail Covers - CAR Length	<b>Add \$70</b>
Substitute RRA Quad Rail with 3 Rail Covers - Mid-Length	<b>Add \$75</b>
Substitute RRA Quad Rail with 3 Rail Covers - Rifle Length	<b>Add \$100</b>
Substitute RRA Half Quad with 3 Rail Covers - Mid-Length	<b>Add \$95</b>
Substitute RRA Wraparound Half Quad - CAR Length	<b>Add \$80</b>
Substitute RRA Wraparound Quad Rail - Mid-Length	<b>Add \$115</b>
Substitute RRA Advanced Half Quad - Mid or Rifle Length	<b>Add \$120</b>
Substitute Hogue Free Float Tube - CAR Length	<b>Add \$30</b>
Substitute Hogue Free Float Tube - Rifle Length	<b>Add \$60</b>

### SUBSTITUTE FOR HOGUE FREE FLOAT TUBE:

Substitute RRA Quad Rail with 3 Rail Covers - CAR Length	<b>Add \$40</b>
Substitute RRA Quad Rail with 3 Rail Covers - Rifle Length	<b>Add \$100</b>
Substitute RRA Advanced Half Quad - Mid or Rifle Length	<b>Add \$70</b>

## HANDGUARD OPTIONS - RRA LAR-8®

### SUBSTITUTE FOR MID-LENGTH - MID-LENGTH GAS SYSTEM:

Substitute RRA Aluminum Free Float Tube	<b>Add \$100</b>
Substitute RRA Quad Rail Free Float with 3 Rail Covers	<b>Add \$165</b>
Substitute RRA Advanced Half Quad with 3 Rail Covers	<b>Add \$200</b>

### SUBSTITUTE FOR A2 - RIFLE LENGTH GAS SYSTEM:

Substitute RRA Aluminum Free Float Tube	<b>Add \$105</b>
Substitute RRA Quad Rail Free Float with 3 Rail Covers	<b>Add \$190</b>
Substitute RRA Advanced Half Quad with 3 Rail Covers	<b>Add \$215</b>

### SUBSTITUTE FOR RRA RIFLE LENGTH FREE FLOAT ALUMINUM TUBE:

Substitute RRA Quad Rail Free Float with 3 Rail Covers	<b>Add \$110</b>
Substitute RRA Advanced Half Quad with 3 Rail Covers	<b>Add \$145</b>



## RRA TRO-CAR Free Float Rail Handguard RRA TRO HANDGUARD OPTIONS

RRA TRO Handguards, in addition to the substitution cost below, require the use of a Low Profile Gas Block. The RRA TRO is not compatible with the LAR-8®.

### SUBSTITUTE FOR CAR, R4, MID-LENGTH OR A2 HANDGUARD:

Substitute RRA TRO-CAR for CAR or R4	<b>Add \$105</b>
Substitute RRA TRO-Mid for CAR, R4 or Mid-Length	<b>Add \$115</b>
Substitute RRA TRO-Std for CAR, R4, Mid-Length or A2	<b>Add \$125</b>
Substitute RRA TRO-XL for CAR, R4, Mid-Length or A2	<b>Add \$140</b>

### SUBSTITUTE FOR HOGUE FREE FLOAT TUBE:

Substitute RRA TRO-CAR for Hogue CAR Length	<b>Add \$20</b>
Substitute RRA TRO-Mid for Hogue CAR Length	<b>Add \$30</b>
Substitute RRA TRO-Std for Hogue CAR Length	<b>Add \$40</b>
Substitute RRA TRO-Std for Hogue Rifle Length	<b>Add \$15</b>
Substitute RRA TRO-XL for Hogue CAR Length	<b>Add \$55</b>
Substitute RRA TRO-XL for Hogue Rifle Length	<b>Add \$30</b>

### SUBSTITUTE FOR OTHER RRA QUAD RAIL HANDGUARDS:

Substitute RRA TRO-CAR for Delta CAR Length	<b>Add \$25</b>
Substitute RRA TRO-Mid for Delta CAR or Mid-Length	<b>Add \$35</b>
Substitute RRA TRO-Mid for RRA Half Quad	<b>No Charge</b>
Substitute RRA TRO-Mid for RRA Advanced Half Quad Mid-Length	<b>No Charge</b>
Substitute RRA TRO-Std for Delta CAR or Mid-Length	<b>Add \$35</b>
Substitute RRA TRO-Std for RRA Half Quad	<b>No Charge</b>
Substitute RRA TRO-Std for RRA Advanced Half Quad Mid or Rifle	<b>No Charge</b>
Substitute RRA TRO-XL for Delta CAR or Mid-Length	<b>Add \$35</b>
Substitute RRA TRO-XL for RRA Half Quad	<b>Add \$10</b>
Substitute RRA TRO-XL for RRA Advanced Half Quad Mid or Rifle	<b>No Charge</b>

### SUBSTITUTE FOR OTHER RRA TRO HANDGUARDS:

Substitute RRA TRO-Mid for TRO-CAR	<b>Add \$10</b>
Substitute RRA TRO-Std for TRO-CAR	<b>Add \$20</b>
Substitute RRA TRO-Std for TRO-Mid	<b>Add \$10</b>
Substitute RRA TRO-XL for TRO-CAR	<b>Add \$35</b>
Substitute RRA TRO-XL for TRO-Mid	<b>Add \$25</b>
Substitute RRA TRO-XL for TRO-Std	<b>Add \$15</b>

## GAS BLOCK/FRONT SIGHT BASE OPTIONS

### SUBSTITUTE FOR A2 FRONT SIGHT BASE:

Substitute Gas Block Sight Base	<b>Add \$35</b>
Substitute Low Profile Gas Block	<b>Add \$80</b>
Substitute RRA Flip Front Sight Gas Block	<b>Add \$80</b>

### SUBSTITUTE FOR GAS BLOCK SIGHT BASE:

Substitute A2 Front Sight Base - .750 diameter barrel	<b>No Charge</b>
Substitute Low Profile Gas Block - .750 diameter barrel	<b>No Charge</b>
Substitute Low Profile Gas Block - Varmint barrel	<b>Add \$20</b>
Substitute Light Varmint Gas Block - .750 diameter barrel	<b>Add \$10</b>
Substitute RRA Flip Front Sight Gas Block	<b>Add \$45</b>
LAR-8®: Sub Low Profile Gas Block (HBAR only)	<b>Add \$10</b>
LAR-8®: Sub LAR-8® Front Sight Housing with Rail (HBAR only)	<b>Add \$20</b>
LAR-8®: Substitute LAR-8® Flip Front Sight Gas Block	<b>Add \$90</b>



## BARREL OPTIONS - 5.56MM/.223

### SUBSTITUTE FOR 16 INCH CHROME MOLY, CAR or MID-LENGTH:

Substitute Chrome Lined, 1:9 Twist	Add \$40
Substitute Chrome Lined Lightweight, 1:9 Twist	Add \$40

### SUBSTITUTE FOR R-4 PROFILE 16 INCH CHROME MOLY:

Substitute Chrome Lined, 1:9 Twist	Add \$40
Substitute Chrome Lined Lightweight, 1:9 Twist	Add \$40

### SUBSTITUTE FOR 20 INCH CHROME MOLY:

Substitute Chrome Lined, 1:9 Twist	Add \$40
Substitute Stainless Steel, 1:8 Twist	Add \$70

## BARREL OPTIONS - 6.8 SPC/.308

### CHROME LINED BARREL SUB FOR CHROME MOLY BARREL:

LAR-6.8 / 6.8 SPC - CAR and Mid-Length A4	Add \$50
LAR-8 / .308 Caliber - Limited Availability	Add \$55

### STAINLESS STEEL SUB FOR 20" CHROME MOLY BARREL:

LAR-8 / .308 Caliber - Stainless Steel, 1:10 Twist	Add \$90
--	----------

## MUZZLE DEVICE OPTIONS

### SUBSTITUTE FOR A1/A2 FLASH HIDER:

Substitute Long A2 Flash Hider - 5.56/.223	Add \$20
Substitute Tactical Long A2 Flash Hider - 5.56/.223	Add \$25
Substitute AWB Military Style Muzzle Brake - 5.56/.223	Add \$35
Substitute AWB RRA Tactical Muzzle Brake - 5.56/.223	Add \$35
Substitute Smith Vortex Flash Hider - 5.56/.223/9mm	Add \$57
Substitute Smith Vortex Flash Hider - 6.8/.458/.308	Add \$88
Substitute Smith AWB Muzzle Brake - 6.8 SPC	Add \$70
Substitute Smith AWB Muzzle Brake - .458/.308	Add \$88
Substitute Smith Vortex for RRA Tactical Brake - 5.56/.223	Add \$30
Pin and Weld Muzzle Device (in addition to cost of device)	Add \$55

## OTHER OPTIONS

### SUBSTITUTE FOR STANDARD CONFIGURATION:

Substitute A2 Upper Receiver for A4 Upper	Add \$50
Substitute UTE2 Upper Receiver for A4 Upper	Add \$90
Substitute EOP Upper Receiver for A4 Upper	Add \$20
Substitute Chromed Bolt Carrier Group - 5.56/.223	Add \$60
Substitute RRA Two Stage Chrome Trigger - 5.56/.223	Add \$35
Substitute Badger Tactical Latch on Charging Handle	Add \$23
Substitute BCMGunfighter Charging Handle	Add \$25
Substitute PRI Gas Buster Charging Handle - 5.56/.223/.308	Add \$65
Substitute PRI Gas Buster Charging Handle - 9mm	Add \$90
Substitute Ambi Charging Handle - 5.56/.223/6.8/.458/9mm	Add \$30
Substitute Ambi Charging Handle - .308	Add \$35
Substitute Ambidextrous Safety Selector	Add \$25
Substitute Ambi-Catch Mag Catch (N/A on LAR-8®, LAR-9®)	Add \$88
Substitute RRA Winter Trigger Guard	Add \$10
Substitute CAR Dual Loop Receiver End Plate	Add \$14
Substitute 1/4 x 1/4 min on Match Rear Sight	No Charge
Substitute .030 Hooded Aperture on Match Rear Sight	No Charge
Bead Blast Stainless Steel Barrel	Add \$35
Substitute 10 Round Magazine - .223	Add \$10
Substitute 10 Round Magazine - 9mm	Add \$10
Substitute 5 or 10 Round Magazine - 6.8 SPC	No Charge
Substitute 3, 5 or 10 Round Polymer Magazine - .308	Add \$15

## BUTTSTOCK OPTIONS

### SUBSTITUTE FOR A2 BUTTSTOCK:

Substitute RRA Entry Buttstock (not available on LAR-8®)	No Charge
Substitute RRA Tactical CAR Stock	Add \$5
Substitute RRA Tactical CAR Stock - Mil Spec (not available on LAR-8®)	Add \$35
Substitute RRA Operator CAR Stock	Add \$50
Substitute RRA Operator CAR Stock - Mil Spec (not available on LAR-8®)	Add \$70
Substitute RRA LAR-8 Operator CAR Stock	Add \$60
Substitute RRA Operator A2 Stock	Add \$50
Substitute RRA Delta CAR Stock	Add \$50
Substitute ACE ARFX Skeleton Stock	Add \$52.50
Substitute ACE ARFX-E Skeleton Stock (not available on LAR-8®)	Add \$52.50
Substitute Magpul PRS Stock (not available on LAR-8®)	Add \$230

### SUBSTITUTE FOR RRA 6-POSITION TACTICAL CAR STOCK:

Substitute RRA Entry Buttstock (not available on LAR-8®)	No Charge
Substitute A2 Buttstock	Add \$5
Substitute RRA Tactical CAR Stock - Mil Spec (not available on LAR-8®)	Add \$20
Substitute RRA Operator CAR Stock	Add \$50
Substitute RRA Operator CAR Stock - Mil Spec (not available on LAR-8®)	Add \$70
Substitute RRA Operator A2 Stock	Add \$50
Substitute ACE ARFX Skeleton Stock	Add \$42.50
Substitute ACE ARFX-E Skeleton Stock (not available on LAR-8®)	Add \$42.50
Substitute Magpul PRS Stock (not available on LAR-8®)	Add \$225

## PISTOL GRIP OPTIONS

### SUBSTITUTE FOR A2 PISTOL GRIP:

Substitute RRA Overmolded A2 Pistol Grip	Add \$15
Substitute Hogue Rubber or ERGO SureGrip Pistol Grip	Add \$20
Substitute ERGO Tactical Deluxe Pistol Grip	Add \$55

### SUBSTITUTE FOR RRA OVERMOLDED A2 PISTOL GRIP:

Substitute Hogue Rubber or ERGO SureGrip Pistol Grip	Add \$3
Substitute ERGO Tactical Deluxe Pistol Grip	Add \$40

### SUBSTITUTE FOR HOGUE RUBBER OR ERGO PISTOL GRIP:

Substitute RRA Overmolded A2, Hogue Rubber or ERGO SureGrip	No Charge
Substitute ERGO Tactical Deluxe Pistol Grip	Add \$45

## COLOR FURNITURE OPTIONS

Green/Tan Furniture on Rifle, where applicable	Add \$10
Green/Tan Furniture on Upper or Lower Half, where applicable	Add \$5

## Smith Enterprises Muzzle Devices:

Smith Enterprises is in the process of changing the appearance of their muzzle devices. Actual Smith Enterprises muzzle devices received may vary in appearance from those pictured in this catalog.

## BAN COMPLIANT MODELS

After the federal Assault Weapon Ban (AWB) of 1994 expired in 2004, several states enacted their own bans. In addition, several other states have recently enacted new bans or modified existing bans. In many cases RRA can provide ban-compliant products, but may not be able to for some markets. Ban compliant variations from the base models may include pinned and welded muzzle brakes or no muzzle device, gas blocks or front sight bases without bayonet lugs, and non-collapsible stocks.

Please visit our website [www.rockriverarms.com](http://www.rockriverarms.com) for additional information or contact **RRA Customer Service** toll free at **866-980-7625**.

# RRA LAR-47 - 7.62x39mm



Chrome Lined Barrel

**RRA LAR-47® CAR A4**  
AK1263

RRA  
Two Stage  
Trigger

RRA  
Tactical  
CAR Stock

# LAR-47®

## 7.62x39MM

RRA Two Piece Quad Rail



RRA  
Delta  
CAR Stock

**RRA LAR-47®**  
**Delta Carbine**  
AK1291

ERGO  
SureGrip

Accepts most standard  
AK-47 magazines!

## RRA LAR-47® CAR A4

Standard Configuration ..... AK1263 **\$1,270**

### STANDARD CONFIGURATION

CALIBER	7.62x39mm
LOWER RECEIVER	RRA Proprietary Forged LAR-47®
UPPER RECEIVER	RRA Proprietary Forged A4
BARREL	16" Chrome Lined HBAR, 1:10 RH Twist / Gas Block Sight Base
MUZZLE DEVICE	A2 Flash Hider / 1/2-36 Thread
TRIGGER	RRA Two Stage / RRA LAR-47 Winter Trigger Guard
BOLT CARRIER GROUP	Chromed 7.62x39mm Bolt Carrier Group
MAG RELEASE	Ambidextrous Mag Release
HANDGUARD	CAR Handguard
BUTTSTOCK	RRA 6-Position Tactical CAR Stock
PISTOL GRIP	A2 Pistol Grip
WEIGHT	6.4 Pounds
LENGTH	36 Inches
INCLUDED	One AK-47 Mag, RRA Case, Manual, Warranty

## RRA LAR-47® Delta Carbine

Standard Configuration ..... AK1291 **\$1,545**

### STANDARD CONFIGURATION

CALIBER	7.62x39mm
LOWER RECEIVER	RRA Proprietary Forged LAR-47®
UPPER RECEIVER	RRA Proprietary Forged A4
BARREL	16" Chrome Lined HBAR, 1:10 RH Twist / Low Profile Gas Block
MUZZLE DEVICE	A2 Flash Hider / 1/2-36 Thread
TRIGGER	RRA Two Stage / RRA LAR-47 Winter Trigger Guard
BOLT CARRIER GROUP	Chromed 7.62x39mm Bolt Carrier Group
MAG RELEASE	Ambidextrous Mag Release
HANDGUARD	RRA Two Piece Quad Rail Handguard
BUTTSTOCK	RRA 6-Position Delta CAR Stock
PISTOL GRIP	ERGO SureGrip
WEIGHT	7.75 Pounds
LENGTH	36.5 Inches
INCLUDED	One AK-47 Mag, RRA Case, Manual, Warranty

Configurations/specs shown are pre-production, final production versions may vary from what is shown/specified.

RRA LAR-47® 7.62x39mm



Available with optional  
LEF-T compatible Rear Sights



**Ambi Charging Handle**

**Left Side Ejection Port  
and Shell Deflector**

**Left Side  
Forward Assist**

**Right Side Bolt Catch  
and Safety Selector**

**Ambi Mag Release**

## RRA LAR-15LH LEF-T®

**Left made right! A true left-handed AR-style rifle.**

All of the quality and precision of the RRA LAR-15®, engineered and outfitted specifically for the left handed shooter! With left hand side ejection port, shell deflector and forward assist, right hand side safety selector and bolt catch, ambidextrous mag release and ambidextrous charging handle.

### RRA LAR-15LH LEF-T® CONFIGURATION

BARREL RIFLING	Left Hand Twist	SHELL DEFLECTOR	Left Side
BOLT CATCH	Right Side	FORWARD ASSIST	Left Side
SAFETY SELECTOR	Right Side	MAG RELEASE	Ambidextrous
EJECTION PORT	Left Side	CHARGING HANDLE	Ambidextrous

### NOTE: RRA LAR-15LH LEF-T® Series Parts, Assemblies and Components Compatibility:

The RRA LAR-15LH LEF-T® Series has been engineered specifically to fit left-handed shooters. Please note that RRA LEF-T upper halves are compatible **ONLY** with RRA LAR-15LH lowers, and will not work with conventional AR lowers or other manufacturers left-handed lowers. RRA LAR-15LH lowers are compatible **ONLY** with RRA LEF-T upper halves, and will not work with conventional AR uppers or other manufacturers left-handed uppers. In addition, many other parts and components are unique to the RRA LAR-15LH LEF-T Series and are **not compatible** with conventional ARs, including, but not limited to, upper and lower receivers, barrels, barrel extensions, bolts, bolt carriers and some sight assemblies.

## RRA LEF-T® Compatible Rear Sight Assemblies



### RRA LEF-T® Tactical Mount Assembly

With A2 Rear Sight  
LH0125ASSY. . . . . \$165



### RRA LEF-T® Dominator2 EOTech Mount

With A2 Rear Sight  
LH0125FASSY. . . . . \$165



### RRA LEF-T® A2 Carry Handle Assembly

With A2 Rear Sight  
LH0052CASY. . . . . \$155



### RRA LEF-T® Stand Alone Rear Sight

With A2 Rear Sight  
LH3305ASY. . . . . \$135

# RRA LAR-15LH LEF-T® Operator-L Series

RRA Flip Front Sight  
Gas Block Assembly

RRA Operator  
CAR Stock

RRA Tactical Muzzle Brake

## STANDARD CONFIGURATION

CALIBER	5.56mm NATO Chamber for 5.56mm & .223 Cal.
LOWER RECEIVER	Forged RRA LAR-15LH®
UPPER RECEIVER	Forged A4 LEF-T®
BARREL	16 Inch Chrome Moly, 1:9 Twist
MUZZLE DEVICE	RRA Tactical Muzzle Brake / 1/2-28 Thread
GAS BLOCK	RRA Flip Front Sight Gas Block Assembly
TRIGGER	RRA Two Stage / Winter Trigger Guard
HANDGUARD	RRA Half Quad Free Float w/3 Rail Covers
BUTTSTOCK / GRIP	RRA Operator CAR Stock / ERGO Grip
WEIGHT / LENGTH / ACCURACY	8.0 lbs / 37" / 1 MOA at 100 yds
INCLUDED	One Mag, RRA Case, Manual, Warranty

Mid-Length  
RRA Half Quad  
Free Float  
Handguard

Half Quad  
Handguard  
style may  
vary from  
picture

RRA  
Two Stage  
Trigger

ERGO  
Grip

## RRA LAR-15LH® LEF-T® Elite Operator-L

Standard Configuration ..... LH1276 **\$1,360**

RRA Operator  
CAR Stock

RRA Flip Front Sight  
Gas Block Assembly

RRA Tactical Muzzle Brake



ERGO  
Grip

RRA  
Two Stage  
Trigger

CAR Length  
RRA Quad Rail  
Free Float  
Handguard

## STANDARD CONFIGURATION

CALIBER	5.56mm NATO Chamber for 5.56mm & .223 Cal.
LOWER RECEIVER	Forged RRA LAR-15LH®
UPPER RECEIVER	Forged A4 LEF-T®
BARREL	16 Inch Chrome Moly, 1:9 Twist
MUZZLE DEVICE	RRA Tactical Muzzle Brake / 1/2-28 Thread
GAS BLOCK	RRA Flip Front Sight Gas Block Assembly
TRIGGER	RRA Two Stage / Winter Trigger Guard
HANDGUARD	RRA CAR Quad Rail Free Float w/3 Rail Covers
BUTTSTOCK / GRIP	RRA Operator CAR Stock / ERGO Grip
WEIGHT / LENGTH / ACCURACY	8.0 lbs / 37" / 1 MOA at 100 yds
INCLUDED	One Mag, RRA Case, Manual, Warranty

## RRA LAR-15LH® LEF-T® Tactical Operator-L

Standard Configuration ..... LH1278 **\$1,360**

RRA Flip Front Sight  
Gas Block Assembly

RRA Operator  
CAR Stock

R-4 Profile Barrel

## STANDARD CONFIGURATION

CALIBER	5.56mm NATO Chamber for 5.56mm & .223 Cal.
LOWER RECEIVER	Forged RRA LAR-15LH®
UPPER RECEIVER	Forged A4 LEF-T®
BARREL	16 Inch Chrome Moly R-4, 1:9 Twist
MUZZLE DEVICE	RRA Tactical Muzzle Brake / 1/2-28 Thread
GAS BLOCK	RRA Flip Front Sight Gas Block Assembly
TRIGGER	RRA Two Stage / Winter Trigger Guard
HANDGUARD	RRA CAR Wraparound Half Quad w/3 Rail Covers
BUTTSTOCK / GRIP	RRA Operator CAR Stock / ERGO Grip
WEIGHT / LENGTH / ACCURACY	8.0 lbs / 37" / 1 MOA at 100 yds
INCLUDED	One Mag, RRA Case, Manual, Warranty

RRA CAR  
Wraparound  
Half Quad  
Free Float  
Handguard

RRA  
Two Stage  
Trigger

ERGO  
Grip

## RRA LAR-15LH® LEF-T® Entry Operator-L

Standard Configuration ..... LH1277 **\$1,360**

RRA LAR-15LH® 5.56MM / .223





CAR Length Gas System

RRA  
Tactical  
CAR Stock

RRA  
Two Stage  
Trigger

## RRA LAR-15LH® LEF-T® CAR A4



Mid-Length Gas System

RRA  
Two Stage  
Trigger

RRA  
Overmolded  
A2 Grip

## RRA LAR-15LH® LEF-T® Mid-Length A4

### RRA LAR-15LH® LEF-T® CAR A4

Standard Configuration ..... LH1850 **\$1,180**

#### STANDARD CONFIGURATION

CALIBER	5.56mm NATO Chamber for 5.56mm & .223 Cal.
LOWER RECEIVER	Forged RRA LAR-15LH®
UPPER RECEIVER	Forged A4 LEF-T® Upper
BARREL	16 Inch Chrome Moly, 1:9 Twist / Gas Block Sight Base
MUZZLE DEVICE	A2 Flash Hider / 1/2-28 Thread
TRIGGER	RRA Two Stage
PISTOL GRIP	RRA Overmolded A2 Grip
BUTTSTOCK	RRA 6-Position Tactical CAR Stock
HANDGUARD	CAR Handguard
WEIGHT / LENGTH	7.1 Pounds / 36 Inches
ACCURACY	1 MOA at 100 yards
INCLUDED	One Mag, RRA Case, Manual, Warranty

### RRA LAR-15LH® LEF-T® Mid-Length A4

Standard Configuration ..... LH1855 **\$1,180**

#### STANDARD CONFIGURATION

CALIBER	5.56mm NATO Chamber for 5.56mm & .223 Cal.
LOWER RECEIVER	Forged RRA LAR-15LH®
UPPER RECEIVER	Forged A4 LEF-T® Upper
BARREL	16 Inch Chrome Moly, 1:9 Twist / Gas Block Sight Base
MUZZLE DEVICE	A2 Flash Hider / 1/2-28 Thread
TRIGGER	RRA Two Stage
PISTOL GRIP	RRA Overmolded A2 Grip
BUTTSTOCK	RRA 6-Position Tactical CAR Stock
HANDGUARD	Mid-Length Handguard
WEIGHT / LENGTH	7.1 Pounds / 36 Inches
ACCURACY	1 MOA at 100 yards
INCLUDED	One Mag, RRA Case, Manual, Warranty

### RRA LEF-T® CAR A4 / Mid A4 Complete Upper Halves

Includes Bolt Carrier Group and  
Charging Handle Assembly

#### STANDARD CONFIGURATION

CALIBER	5.56mm NATO Chamber for 5.56mm & .223 Cal.
UPPER RECEIVER	Forged A4 LEF-T® Upper
BARREL	16 Inch Chrome Moly, 1:9 Twist / Gas Block Sight Base
MUZZLE DEVICE	A2 Flash Hider / 1/2-28 Thread

NOTE: FOR USE ONLY WITH RRA LAR-15LH LEF-T® LOWERS



#### LEF-T® CAR A4 Complete Upper Half

With CAR Handguard ..... LH0328B **\$575**



#### LEF-T® Mid-Length A4 Complete Upper Half

With Mid-Length Handguard ..... LH0388B **\$575**

RRA LAR-15LH® 5.56MM / .223

NEW FOR 2013!

RRA LAR-15LH® 5.56MM / .223



## RRA LAR-15LH® LEF-T® Standard A4

A2 Stock

RRA  
Two Stage  
Trigger

A2 Stock

RRA  
Overmolded  
A2 Grip



RRA Aluminum Free Float Tube

Heavy Match  
Stainless Steel Barrel  
Cryo Treated

## RRA LAR-15LH® LEF-T® Predator Pursuit™ Rifle

### RRA LAR-15LH® LEF-T® Standard A4

Standard Configuration ..... LH1288 **\$1,155**

#### STANDARD CONFIGURATION

CALIBER	.223 Wylde Chamber for 5.56mm & .223 Cal.
LOWER RECEIVER	Forged RRA LAR-15LH®
UPPER RECEIVER	Forged A4 LEF-T® Upper
BARREL	20 Inch Chrome Moly HBAR, 1:9 Twist
MUZZLE DEVICE	A2 Flash Hider / 1/2-28 Thread
TRIGGER	RRA Two Stage
BUTTSTOCK / PISTOL GRIP	A2 Buttstock / RRA Overmolded A2 Grip
HANDGUARD	A2 Handguard
WEIGHT / LENGTH	8.2 Pounds / 39.5 Inches
ACCURACY	1 MOA at 100 yards
INCLUDED	One Mag, RRA Case, Manual, Warranty

### RRA LAR-15LH® LEF-T® Predator Pursuit™ Rifle

Standard Configuration ..... LH1530 **\$1,335**

#### STANDARD CONFIGURATION

CALIBER	.223 Wylde Chamber for 5.56mm & .223 Cal.
LOWER RECEIVER	Forged RRA LAR-15LH®
UPPER RECEIVER	Forged A4 LEF-T® Upper
BARREL	20 Inch Heavy Match Stainless, 1:8 Twist, Cryo Treated
GAS BLOCK	Light Varmint Gas Block with Sight Rail
TRIGGER	RRA Two Stage / RRA Winter Trigger Guard
BUTTSTOCK / PISTOL GRIP	A2 Buttstock / Hogue Rubber Grip
HANDGUARD	RRA Aluminum Free Float Tube, Rifle Length
WEIGHT / LENGTH	8.1 Pounds / 38.25 Inches
ACCURACY	3/4 MOA at 100 yards
INCLUDED	One Mag, RRA Case, Manual, Warranty

## RRA LEF-T® Standard A4 & Predator Pursuit™ Complete Upper Halves

Includes Bolt Carrier Group and Charging Handle Assembly



### LEF-T® Standard A4 Rifle

Complete Upper Half ..... LH0450B **\$565**

#### STANDARD CONFIGURATION

CALIBER	.223 Wylde Chamber for 5.56mm & .223 Cal.
UPPER RECEIVER	Forged A4 LEF-T® Upper
BARREL	20 Inch Chrome Moly HBAR, 1:9 Twist
MUZZLE DEVICE	A2 Flash Hider / 1/2-28 Thread
HANDGUARD	A2 Handguard

**NOTE: FOR USE ONLY WITH RRA LAR-15LH LEF-T® LOWERS**

### LEF-T® Predator Pursuit™ Rifle

Complete Upper Half ..... LH0565 **\$820**

#### STANDARD CONFIGURATION

CALIBER	.223 Wylde Chamber for 5.56mm & .223 Cal.
UPPER RECEIVER	Forged A4 LEF-T® Upper
BARREL	20 Inch Heavy Match Stainless Steel, 1:8 Twist, Cryo Treated
GAS BLOCK	Light Varmint Gas Block with Sight Rail
HANDGUARD	RRA Aluminum Free Float Tube, Rifle Length

**NOTE: FOR USE ONLY WITH RRA LAR-15LH LEF-T® LOWERS**

NEW FOR 2013!





**RRA LAR-15LH®  
LEF-T® Coyote Rifle**

Light Varmint Gas Block Sight Base

**RRA LAR-15LH®  
LEF-T® Coyote Carbine**



**RRA LAR-15LH®  
LEF-T® Coyote Carbine**

**RRA LAR-15LH®  
LEF-T® Coyote Rifle**

Standard Configuration ..... LH1535 **\$1,450**

Standard Configuration ..... LH1540 **\$1,400**

**STANDARD CONFIGURATION**

CALIBER	.223 Wylde Chamber for 5.56mm & .223 Cal.
LOWER RECEIVER	Forged RRA LAR-15LH®
UPPER RECEIVER	Forged A4 LEF-T® Upper
BARREL	20 Inch Chrome Moly HBAR, 1:9 Twist
MUZZLE DEVICE	Smith Vortex Flash Hider / 1/2-28 Thread
GAS BLOCK	Light Varmint Gas Block with Sight Rail
TRIGGER	RRA Two Stage / RRA Winter Trigger Guard
BUTTSTOCK / PISTOL GRIP	RRA Operator A2 Stock / Hogue Rubber Grip
HANDGUARD	Hogue Overmolded Free Float Tube, Rifle Length
WEIGHT / LENGTH	8.4 Pounds / 40 Inches
ACCURACY	3/4 MOA at 100 yards
INCLUDED	One Mag, RRA Case, Manual, Warranty

**STANDARD CONFIGURATION**

CALIBER	5.56mm NATO Chamber for 5.56mm & .223 Cal.
LOWER RECEIVER	Forged RRA LAR-15LH®
UPPER RECEIVER	Forged A4 LEF-T® Upper
BARREL	16 Inch Chrome Moly HBAR, 1:9 Twist
MUZZLE DEVICE	Smith Vortex Flash Hider / 1/2-28 Thread
GAS BLOCK	Light Varmint Gas Block with Sight Rail
TRIGGER	RRA Two Stage / RRA Winter Trigger Guard
BUTTSTOCK / PISTOL GRIP	RRA Operator A2 Stock / Hogue Rubber Grip
HANDGUARD	Hogue Overmolded Free Float Tube, CAR Length
WEIGHT / LENGTH	7.0 Pounds / 36 Inches
ACCURACY	3/4 MOA at 100 yards
INCLUDED	One Mag, RRA Case, Manual, Warranty

**RRA LEF-T® Coyote Rifle & Carbine Complete Upper Halves**  
Includes Bolt Carrier Group and Charging Handle Assembly



**LEF-T® Coyote Rifle**

Complete Upper Half ..... LH0585 **\$770**

**LEF-T® Coyote Carbine**

Complete Upper Half ..... LH0590 **\$720**

**STANDARD CONFIGURATION**

CALIBER	.223 Wylde Chamber for 5.56mm & .223 Cal.
UPPER RECEIVER	Forged A4 LEF-T® Upper
BARREL	20 Inch Chrome Moly HBAR, 1:9 Twist
MUZZLE DEVICE	Smith Vortex Flash Hider / 1/2-28 Thread
HANDGUARD	Hogue Overmolded Free Float Tube, Rifle Length

**NOTE: FOR USE ONLY WITH RRA LAR-15LH LEF-T® LOWERS**

**STANDARD CONFIGURATION**

CALIBER	5.56mm NATO Chamber for 5.56mm & .223 Cal.
UPPER RECEIVER	Forged A4 LEF-T® Upper
BARREL	16 Inch Chrome Moly HBAR, 1:9 Twist
MUZZLE DEVICE	Smith Vortex Flash Hider / 1/2-28 Thread
HANDGUARD	Hogue Overmolded Free Float Tube, CAR Length

**NOTE: FOR USE ONLY WITH RRA LAR-15LH LEF-T® LOWERS**

RRA LAR-15LH® 5.56MM / .223 NEW FOR 2013!

Cryo Treated, Air Gauged  
Stainless Steel Bull Barrel

New RRA TRO-Std Free Float Handguard  
TRO - Top Rail Octagonal  
over Low Profile Gas Block

## RRA LAR-15LH® LEF-T® 24 Inch Varmint A4

RRA  
Two Stage  
Trigger



A2 Stock

Hogue  
Grip

RRA  
Winter  
Trigger Guard

## RRA LAR-15LH® LEF-T® 20 Inch Varmint A4

### RRA LAR-15LH® LEF-T® 24 Inch Varmint A4

Standard Configuration ..... LH1550 \$1,400

#### STANDARD CONFIGURATION

CALIBER	.223 Wylde Chamber for 5.56mm & .223 Cal.
LOWER RECEIVER	Forged RRA LAR-15LH®
UPPER RECEIVER	Forged A4 LEF-T® Upper
BARREL	24 Inch Air Gauged Stainless Steel Bull, 1:8 Twist, Cryo Treated
GAS BLOCK	Low Profile Gas Block
TRIGGER / TRIGGER GUARD	RRA Two Stage / RRA Winter Trigger Guard
BUTTSTOCK / PISTOL GRIP	A2 Buttstock / Hogue Rubber Grip
HANDGUARD	RRA TRO-Std Free Float - Top Rail Octagonal
WEIGHT / LENGTH	9.7 Pounds / 42.25 Inches
ACCURACY	3/4 MOA at 100 yards
INCLUDED	One Mag, RRA Case, Manual, Warranty

### RRA LAR-15LH® LEF-T® 20 Inch Varmint A4

Standard Configuration ..... LH1520 \$1,390

#### STANDARD CONFIGURATION

CALIBER	.223 Wylde Chamber for 5.56mm & .223 Cal.
LOWER RECEIVER	Forged RRA LAR-15LH®
UPPER RECEIVER	Forged A4 LEF-T® Upper
BARREL	20 Inch Air Gauged Stainless Steel Bull, 1:8 Twist, Cryo Treated
GAS BLOCK	Low Profile Gas Block
TRIGGER / TRIGGER GUARD	RRA Two Stage / RRA Winter Trigger Guard
BUTTSTOCK / PISTOL GRIP	A2 Buttstock / Hogue Rubber Grip
HANDGUARD	RRA TRO-Std Free Float - Top Rail Octagonal
WEIGHT / LENGTH	9.2 Pounds / 38.25 Inches
ACCURACY	3/4 MOA at 100 yards
INCLUDED	One Mag, RRA Case, Manual, Warranty

## RRA LEF-T® Varmint A4 Complete Upper Halves

Includes Bolt Carrier Group and Charging Handle Assembly

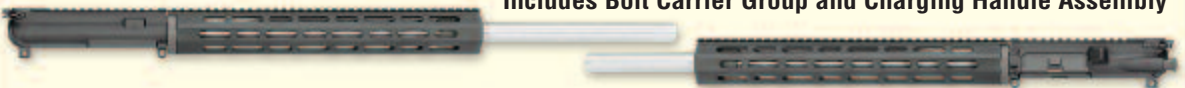

### LEF-T® 24 Inch Varmint A4 Complete Upper Half ..... LH0575 \$765

#### STANDARD CONFIGURATION

CALIBER	.223 Wylde Chamber for 5.56mm & .223 Cal.
UPPER RECEIVER	Forged A4 LEF-T® Upper
BARREL	24 Inch Air Gauged Stainless Steel Bull, 1:8 Twist, Cryo Treated
GAS BLOCK	Low Profile Gas Block
HANDGUARD	RRA TRO-Std Free Float - Top Rail Octagonal

NOTE: FOR USE ONLY WITH RRA LAR-15LH LEF-T® LOWERS

### LEF-T® 20 Inch Varmint A4 Complete Upper Half ..... LH0550 \$755

#### STANDARD CONFIGURATION

CALIBER	.223 Wylde Chamber for 5.56mm & .223 Cal.
UPPER RECEIVER	Forged A4 LEF-T® Upper
BARREL	20 Inch Air Gauged Stainless Steel Bull, 1:8 Twist, Cryo Treated
GAS BLOCK	Low Profile Gas Block
HANDGUARD	RRA TRO-Std Free Float - Top Rail Octagonal

NOTE: FOR USE ONLY WITH RRA LAR-15LH LEF-T® LOWERS

RRA LAR-15LH® 5.56MM / .223

NEW FOR 2013!



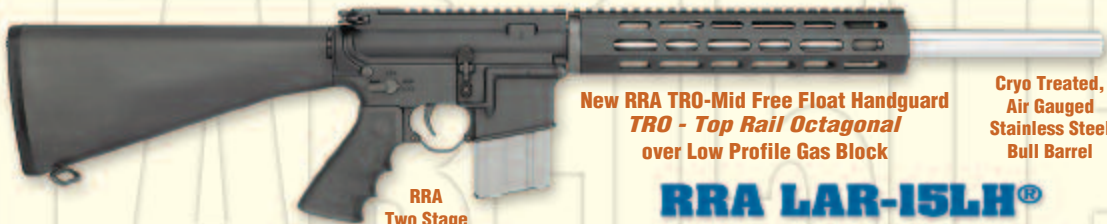

New RRA TRO-Mid Free Float Handguard  
TRO - Top Rail Octagonal  
over Low Profile Gas Block

Cryo Treated,  
Air Gauged  
Stainless Steel  
Bull Barrel

RRA  
Two Stage  
Trigger

## RRA LAR-15LH® LEF-T® 18 Inch Varmint A4



New RRA TRO-CAR Free Float Handguard

## RRA LAR-15LH® LEF-T® 16 Inch Varmint A4

RRA  
Winter  
Trigger Guard

Hogue  
Grip

A2 Stock

## RRA LAR-15LH® LEF-T® 18 Inch Varmint A4

Standard Configuration ..... LH1515 \$1,375

### STANDARD CONFIGURATION

CALIBER	.223 Wylde Chamber for 5.56mm & .223 Cal.
LOWER RECEIVER	Forged RRA LAR-15LH®
UPPER RECEIVER	Forged A4 LEF-T® Upper
BARREL	18 Inch Air Gauged Stainless Steel Bull, 1:8 Twist, Cryo Treated
GAS BLOCK	Low Profile Gas Block
TRIGGER / TRIGGER GUARD	RRA Two Stage / RRA Winter Trigger Guard
BUTTSTOCK / PISTOL GRIP	A2 Buttstock / Hogue Rubber Grip
HANDGUARD	RRA TRO-Mid Free Float - Top Rail Octagonal
WEIGHT / LENGTH	8.7 Pounds / 36.25 Inches
ACCURACY	3/4 MOA at 100 yards
INCLUDED	One Mag, RRA Case, Manual, Warranty

## RRA LAR-15LH® LEF-T® 16 Inch Varmint A4

Standard Configuration ..... LH1500 \$1,360

### STANDARD CONFIGURATION

CALIBER	.223 Wylde Chamber for 5.56mm & .223 Cal.
LOWER RECEIVER	Forged RRA LAR-15LH®
UPPER RECEIVER	Forged A4 LEF-T® Upper
BARREL	16 Inch Air Gauged Stainless Steel Bull, 1:8 Twist, Cryo Treated
GAS BLOCK	Low Profile Gas Block
TRIGGER / TRIGGER GUARD	RRA Two Stage / RRA Winter Trigger Guard
BUTTSTOCK / PISTOL GRIP	A2 Buttstock / Hogue Rubber Grip
HANDGUARD	RRA TRO-CAR Free Float - Top Rail Octagonal
WEIGHT / LENGTH	7.9 Pounds / 34.25 Inches
ACCURACY	3/4 MOA at 100 yards
INCLUDED	One Mag, RRA Case, Manual, Warranty

## RRA LEF-T® Varmint A4 Complete Upper Halves

Includes Bolt Carrier Group and Charging Handle Assembly



### LEF-T® 18 Inch Varmint A4

Complete Upper Half ..... LH0525 \$740

#### STANDARD CONFIGURATION

CALIBER	.223 Wylde Chamber for 5.56mm & .223 Cal.
UPPER RECEIVER	Forged A4 LEF-T® Upper
BARREL	18 Inch Air Gauged Stainless Steel Bull, 1:8 Twist, Cryo Treated
GAS BLOCK	Low Profile Gas Block
HANDGUARD	RRA TRO-Mid Free Float - Top Rail Octagonal

NOTE: FOR USE ONLY WITH RRA LAR-15LH LEF-T® LOWERS

### LEF-T® 16 Inch Varmint A4

Complete Upper Half ..... LH0500 \$725

#### STANDARD CONFIGURATION

CALIBER	.223 Wylde Chamber for 5.56mm & .223 Cal.
UPPER RECEIVER	Forged A4 LEF-T® Upper
BARREL	16 Inch Air Gauged Stainless Steel Bull, 1:8 Twist, Cryo Treated
GAS BLOCK	Low Profile Gas Block
HANDGUARD	RRA TRO-CAR Free Float - Top Rail Octagonal

NOTE: FOR USE ONLY WITH RRA LAR-15LH LEF-T® LOWERS

RRA LAR-15LH® 5.56MM / .223

NEW FOR 2013!

**A 3-Gun competition ready rifle, right out of the box!**



**New RRA TRO-XL Free Float Handguard  
TRO - Top Rail Octagonal  
XL - 15 Inch Extended Length**

**RRA  
Operator  
A2 Stock**  
**Hogue  
Grip**

**RRA  
Two Stage  
Trigger**



*Featuring a cryo treated 18 inch  
fluted stainless steel barrel with  
RRA's directionally tuned and  
ported muzzle brake.*

**RRA LAR-15®  
R3 Competition Rifle**



**RRA  
Operator  
CAR Stock**

**RRA  
Winter  
Trigger Guard**

**Low Profile Gas Block  
Mid-Length Gas System**

**RRA LAR-15®  
R3 Competition Rifle**

With RRA Operator A2 Stock ..... AR1705 **\$1,310**  
With RRA Operator CAR Stock ..... AR1700 **\$1,310**

**RRA LAR-15® R3 COMPETITION RIFLE - STANDARD CONFIGURATION**

CALIBER	.223 Wylde Chamber for 5.56mm & .223 Cal.	HANDGUARD	RRA TRO-XL Free Float - Top Rail Octagonal Extended Length
LOWER / UPPER RECEIVER	Forged RRA LAR-15® / Forged A4 Upper	PISTOL GRIP	Hogue Rubber Grip
BARREL	18 Inch Fluted Stainless Steel, 1:8 Twist, Cryo Treated	WITH OPERATOR A2 STOCK : WEIGHT / LENGTH	7.6 Pounds / 38 Inches
MUZZLE	RRA Directionally-Tuned and Ported Brake / 1/2-28 Thread	WITH OPERATOR CAR STOCK : WEIGHT	7.6 Pounds
GAS BLOCK	Low Profile Gas Block	WITH OPER CAR STOCK : LENGTH	35.75" Retracted / 39.25" Extended
TRIGGER	RRA Two Stage Match / RRA Winter Trigger Guard	ACCURACY	3/4 MOA at 100 Yards
SAFETY SELECTOR	Star Safety	INCLUDED	One Mag, RRA Case, Manual, Warranty

**R3 Competition Rifle Complete Upper Half**

**STANDARD CONFIGURATION**

CALIBER	.223 Wylde Chamber for 5.56mm & .223 Cal.
UPPER RECEIVER	Forged A4 Upper
BARREL	18 Inch Fluted Stainless Steel, 1:8 Twist, Cryo Treated
MUZZLE DEVICE	RRA Tuned and Ported Brake / 1/2-28 Thread
GAS BLOCK	Low Profile Gas Block
HANDGUARD	RRA TRO-XL Free Float - Top Rail Octagonal

**Includes Bolt Carrier Group and Charging Handle Assembly**



**R3 Competition Rifle Complete Upper Half**

**Standard Configuration ..... AR0700 \$715**

**RRA LAR-15® 5.56MM / .223**

**NEW FOR 2013!**



RRA Delta CAR Stock

ERGO SureGrip

RRA Two Stage Trigger

New RRA Delta Quad Rail CAR  
Two Piece Drop-in Handguard

Low Profile Gas Block

## RRA LAR-15<sup>®</sup> Delta CAR



Low Profile Gas Block

New RRA Delta Quad Rail Mid-Length  
Two Piece Drop-in Handguard

RRA Winter Trigger Guard

RRA Delta CAR Stock

## RRA LAR-15<sup>®</sup> Delta Mid-Length

### RRA LAR-15<sup>®</sup> Delta CAR

Standard Configuration ..... AR1410 **\$1,085**

#### STANDARD CONFIGURATION

CALIBER	5.56mm NATO Chamber for 5.56mm & .223 Cal.
LOWER RECEIVER	Forged RRA LAR-15 <sup>®</sup> Lower
UPPER RECEIVER	Forged A4 Upper
BARREL	16 Inch Chrome Moly HBAR, 1:9 Twist
MUZZLE DEVICE	A2 Flash Hider / 1/2-28 Thread
GAS BLOCK	Low Profile Gas Block
TRIGGER / TRIGGER GUARD	RRA Two Stage / Winter Trigger Guard
BUTTSTOCK	RRA Delta CAR Stock
PISTOL GRIP	ERGO SureGrip
HANDGUARD	RRA Delta Quad Rail CAR Two Piece Drop-In
WEIGHT / LENGTH	7 Pounds / 33 Inches Retracted / 36.75 Inches Extended
ACCURACY	1 MOA at 100 yds
INCLUDED	One Mag, RRA Case, Manual, Warranty

### RRA LAR-15<sup>®</sup> Delta Mid-Length

Standard Configuration ..... AR1415 **\$1,085**

#### STANDARD CONFIGURATION

CALIBER	5.56mm NATO Chamber for 5.56mm & .223 Cal.
LOWER RECEIVER	Forged RRA LAR-15 <sup>®</sup> Lower
UPPER RECEIVER	Forged A4 Upper
BARREL	16 Inch Chrome Moly HBAR, 1:9 Twist
MUZZLE DEVICE	A2 Flash Hider / 1/2-28 Thread
GAS BLOCK	Low Profile Gas Block
TRIGGER / TRIGGER GUARD	RRA Two Stage / Winter Trigger Guard
BUTTSTOCK	RRA Delta CAR Stock
PISTOL GRIP	ERGO SureGrip
HANDGUARD	RRA Delta Quad Rail Mid-Length Two Piece Drop-In
WEIGHT / LENGTH	7.3 Pounds / 33 Inches Retracted / 36.75 Inches Extended
ACCURACY	1 MOA at 100 yds
INCLUDED	One Mag, RRA Case, Manual, Warranty

## Delta CAR & Mid-Length Complete Upper Halves

Includes Bolt Carrier Group and Charging Handle Assembly



### Delta CAR Complete Upper Half

With Delta Quad Rail CAR Handguard ..... AR0645 **\$665**



### Delta Mid-Length Complete Upper Half

With Delta Quad Rail Mid-Length Handguard ..... AR0695 **\$665**

#### STANDARD CONFIGURATION

CALIBER	5.56mm NATO Chamber for 5.56 & .223 Cal.
UPPER RECEIVER	Forged A4 Upper
BARREL	16 Inch Chrome Moly HBAR, 1:9 Twist
MUZZLE DEVICE	A2 Flash Hider / 1/2-28 Thread
GAS BLOCK	Low Profile Gas Block
HANDGUARD	RRA Delta Quad Rail Two Piece Drop-In



RRA LAR-15® 5.56MM / .223



RRA Operator CAR Stock

ERGO SureGrip

RRA Two Stage Trigger and RRA Winter Trigger Guard

RRA Half Quad Free Float and 3 Ladder Rail Covers

Chrome Lined Barrel with RRA Tactical Muzzle Brake

# RRA LAR-15® Elite Comp



RRA Flip Front Sight Gas Block Assembly

A.R.M.S. #40L Low Profile Flip-up Rear Sight

Mid-Length Gas System

Half Quad Handguard style may vary from picture

## STANDARD CONFIGURATION

CALIBER	5.56mm NATO Chamber for 5.56mm & .223 Cal.
LOWER RECEIVER	Forged RRA LAR-15®
UPPER RECEIVER	Forged A4 Upper
BARREL	Chrome Lined 16 Inch Chrome Moly, 1:9 Twist
MUZZLE DEVICE	RRA Tactical Muzzle Brake / 1/2-28 Thread
GAS BLOCK	RRA Flip Front Sight Gas Block Assembly
TRIGGER	RRA Two Stage
TRIGGER GUARD	RRA Winter Trigger Guard
SAFETY SELECTOR	Star Safety
REAR SIGHT	A.R.M.S. #40L Low Profile Flip-up Rear Sight
PISTOL GRIP	ERGO SureGrip
BUTTSTOCK	RRA Operator CAR Stock
HANDGUARD	RRA Half Quad Free Float with Full Top Rail and 3 Rail Covers
WEIGHT / LENGTH	8.4 Pounds / 36 Inches
ACCURACY	1.5 MOA at 100 Yards
INCLUDED	One Mag, RRA Case, Manual, Warranty

## RRA LAR-15® Elite Comp

Standard Configuration ..... AR1270 \$1,515

### POPULAR OPTIONS AND UPGRADES

Substitute Hogue Rubber Pistol Grip	No Charge
Substitute Chromed Bolt Carrier Group	Add \$60
Substitute RRA Two Stage Chrome Trigger	Add \$35
Substitute Badger Tactical Latch on Charging Handle	Add \$23
Substitute BCM Gunfighter Charging Handle	Add \$25
Substitute PRI Gas Buster Charging Handle	Add \$65
Substitute Ambidextrous Charging Handle	Add \$30

COMPLETE OPTIONS & UPGRADES LISTING ON PAGES 4 & 5

# Elite Comp Complete Upper Half

Includes Bolt Carrier Group and Charging Handle Assembly



## Elite Comp Complete Upper Half

Standard Configuration ..... AR0835B \$920

### STANDARD CONFIGURATION

CALIBER	5.56mm NATO Chamber for 5.56mm & .223 Cal.
UPPER RECEIVER	Forged A4 Upper
BARREL	Chrome Lined 16 Inch Chrome Moly, 1:9 Twist
MUZZLE DEVICE	RRA Tactical Muzzle Brake / 1/2-28 Thread
GAS BLOCK	RRA Flip Front Sight Gas Block Assembly
REAR SIGHT	A.R.M.S. #40L Low Profile Flip-up Rear Sight
HANDGUARD	RRA Half Quad with Full Top Rail and 3 Rail Covers

**RRA Tactical  
CAR Stock**

**R-4 Handguard**  
With double heat shields

**R-4 Barrel Profile**  
Available in optional chrome lined  
and lightweight configurations

**Side Mount  
Sling Swivel**

**CAR Length Gas System**

**Hogue  
Grip**

**RRA  
Two Stage  
Trigger**

# RRA LAR-15® Entry Tactical

Shown with optional  
RRA Dominator2 Mount  
See Page 68

## RRA LAR-15® Entry Tactical

**With Chrome Moly R-4 Barrel**

Standard Configuration ..... AR1252 **\$1,065**

**With CHROME LINED Chrome Moly R-4 Barrel**

Standard Configuration ..... AR1256 **\$1,105**

### STANDARD CONFIGURATION

CALIBER	5.56mm NATO Chamber for 5.56mm & .223 Cal.
LOWER RECEIVER	Forged RRA LAR-15®
UPPER RECEIVER	Forged A4 Upper
BARREL	16 Inch Chrome Moly R-4 Profile, 1:9 Twist
MUZZLE DEVICE	A2 Flash Hider / 1/2-28 Thread
TRIGGER	RRA Two Stage
SAFETY SELECTOR	Star Safety
PISTOL GRIP	Hogue Rubber Grip
BUTTSTOCK	RRA 6-Position Tactical CAR Stock
HANDGUARD	R-4 Handguard with Double Heat Shields
WEIGHT / LENGTH	7.5 Pounds / 36 Inches
ACCURACY	1 MOA at 100 Yards
INCLUDED	One Mag, RRA Case, Manual, Warranty

### POPULAR OPTIONS AND UPGRADES

Substitute RRA Quad Rail with 3 Rail Covers	<b>Add \$145</b>
Substitute RRA Flip Front Sight Gas Block	<b>Add \$80</b>
Substitute AWB RRA Tactical Muzzle Brake	<b>Add \$35</b>
Substitute Smith Vortex Flash Hider	<b>Add \$57</b>
Substitute RRA Operator CAR Stock	<b>Add \$50</b>
Substitute ERGO SureGrip Pistol Grip	<b>No Charge</b>
Substitute Chromed Bolt Carrier Group	<b>Add \$60</b>
Substitute Badger Tac Latch on Charging Handle	<b>Add \$23</b>
Substitute BCMGunfighter Charging Handle	<b>Add \$25</b>
Substitute RRA Winter Trigger Guard	<b>Add \$10</b>
Substitute CAR Dual Loop Receiver End Plate	<b>Add \$14</b>

**COMPLETE OPTIONS & UPGRADES LISTING ON PAGES 4 & 5**

## Entry Tactical Complete Upper Half

**Includes Bolt Carrier Group and  
Charging Handle Assembly**

### STANDARD CONFIGURATION

CALIBER	5.56mm NATO Chamber for 5.56mm & .223 Cal.
UPPER RECEIVER	Forged A4 Upper
MUZZLE DEVICE	A2 Flash Hider / 1/2-28 Thread
HANDGUARD	R-4 Handguard with Double Heat Shields



## Entry Tactical Complete Upper Half

**With 16" Chrome Moly R-4 Barrel, 1:9 Twist**

Standard Configuration ..... AR0841B **\$570**

**With CHROME LINED 16" Chrome Moly R-4 Barrel, 1:9 Twist**

Standard Configuration ..... AR0847B **\$610**

RRA LAR-15® 5.56MM / .223

RRA LAR-15® 5.56MM / .223



# RRA LAR-15® Tactical CAR A4

Shown with optional  
RRA Tactical Mount  
See Page 68

## RRA LAR-15® Tactical CAR A4

With Chrome Moly Barrel

Standard Configuration ..... AR1201 **\$1,065**

With CHROME LINED Chrome Moly Barrel

Standard Configuration ..... AR1207 **\$1,105**

### POPULAR OPTIONS AND UPGRADES

Substitute RRA Quad Rail with 3 Rail Covers	<b>Add \$145</b>
Substitute RRA Flip Front Sight Gas Block	<b>Add \$80</b>
Substitute AWB RRA Tactical Muzzle Brake	<b>Add \$35</b>
Substitute Smith Vortex Flash Hider	<b>Add \$57</b>
Substitute RRA Operator CAR Stock	<b>Add \$50</b>
Substitute ERGO SureGrip Pistol Grip	<b>No Charge</b>
Substitute Chromed Bolt Carrier Group	<b>Add \$60</b>
Substitute Badger Tac Latch on Charging Handle	<b>Add \$23</b>
Substitute BCMGunfighter Charging Handle	<b>Add \$25</b>
Substitute RRA Winter Trigger Guard	<b>Add \$10</b>
Substitute CAR Dual Loop Receiver End Plate	<b>Add \$14</b>

**COMPLETE OPTIONS & UPGRADES LISTING ON PAGES 4 & 5**

### STANDARD CONFIGURATION

CALIBER	5.56mm NATO Chamber for 5.56mm & .223 Cal.
LOWER RECEIVER	Forged RRA LAR-15®
UPPER RECEIVER	Forged A4 Upper
BARREL	16 Inch Chrome Moly, 1:9 Twist
MUZZLE DEVICE	A2 Flash Hider / 1/2-28 Thread
TRIGGER	RRA Two Stage
SAFETY SELECTOR	Star Safety
PISTOL GRIP	Hogue Rubber Grip
BUTTSTOCK	RRA 6-Position Tactical CAR Stock
HANDGUARD	R-4 Handguard
WEIGHT / LENGTH	7.5 Pounds / 36 Inches
ACCURACY	1 MOA at 100 Yards
INCLUDED	One Mag, RRA Case, Manual, Warranty



## Tactical CAR A4 Complete Upper Half

With 16" Chrome Moly Barrel, 1:9 Twist

Standard Configuration ..... AR0886B **\$570**

With CHROME LINED 16" Chrome Moly Barrel, 1:9 Twist

Standard Configuration ..... AR0851B **\$610**

## Tactical CAR A4 Complete Upper Half

Includes Bolt Carrier Group and  
Charging Handle Assembly

### STANDARD CONFIGURATION

CALIBER	5.56mm NATO Chamber for 5.56mm & .223 Cal.
UPPER RECEIVER	Forged A4 Upper
MUZZLE DEVICE	A2 Flash Hider / 1/2-28 Thread
HANDGUARD	R-4 Handguard



**RRA Tactical  
CAR Stock**

**Mid-Length Handguard**

**Side Mount  
Sling Swivel**

**Mid-Length Gas System**

**Hogue  
Grip**

**RRA  
Two Stage  
Trigger**

# RRA LAR-15® Elite CAR A4

*Shown with optional  
UTE2 Upper Receiver  
with integral rear sight*

## RRA LAR-15® Elite CAR A4

**With Chrome Moly Barrel**

Standard Configuration ..... AR1226 **\$1,065**

**With CHROME LINED Chrome Moly Barrel**

Standard Configuration ..... AR1231 **\$1,105**

### STANDARD CONFIGURATION

CALIBER	5.56mm NATO Chamber for 5.56mm & .223 Cal.
LOWER RECEIVER	Forged RRA LAR-15®
UPPER RECEIVER	Forged A4 Upper
BARREL	16 Inch Chrome Moly, 1:9 Twist
MUZZLE DEVICE	A2 Flash Hider / 1/2-28 Thread
TRIGGER	RRA Two Stage
SAFETY SELECTOR	Star Safety
PISTOL GRIP	Hogue Rubber Grip
BUTTSTOCK	RRA 6-Position Tactical CAR Stock
HANDGUARD	Mid-Length Handguard
WEIGHT / LENGTH	7.7 Pounds / 36 Inches
ACCURACY	1 MOA at 100 Yards
INCLUDED	One Mag, RRA Case, Manual, Warranty

### POPULAR OPTIONS AND UPGRADES

Substitute RRA Aluminum Free Float Tube	<b>Add \$65</b>
Substitute RRA Quad Rail with 3 Rail Covers	<b>Add \$155</b>
Substitute RRA Half Quad with 3 Rail Covers	<b>Add \$165</b>
Substitute RRA Advanced Half Quad with 3 Rail Covers	<b>Add \$180</b>
Substitute RRA Wraparound Quad with 3 Rail Covers	<b>Add \$195</b>
Substitute RRA Flip Front Sight Gas Block	<b>Add \$80</b>
Substitute AWB RRA Tactical Muzzle Brake	<b>Add \$35</b>
Substitute Smith Vortex Flash Hider	<b>Add \$57</b>
Substitute RRA Operator CAR Stock	<b>Add \$50</b>
Substitute Chromed Bolt Carrier Group	<b>Add \$60</b>
Substitute RRA Ambidextrous Charging Handle	<b>Add \$30</b>

**COMPLETE OPTIONS & UPGRADES LISTING ON PAGES 4 & 5**

## Elite CAR A4 Complete Upper Half

**Includes Bolt Carrier Group and  
Charging Handle Assembly**

### STANDARD CONFIGURATION

CALIBER	5.56mm NATO Chamber for 5.56mm & .223 Cal.
UPPER RECEIVER	Forged A4 Flattop
MUZZLE DEVICE	A2 Flash Hider / 1/2-28 Thread
HANDGUARD	Mid-Length Handguard



## Elite CAR A4 Complete Upper Half

**With 16" Chrome Moly Barrel, 1:9 Twist**

Standard Configuration ..... AR0875B **\$570**

**With CHROME LINED 16" Chrome Moly Barrel, 1:9 Twist**

Standard Configuration ..... AR0831B **\$610**

RRA LAR-15® 5.56MM / .223

RRA LAR-15® 5.56MM / .223



# RRA LAR-15® CAR A4



## RRA LAR-15® CAR A4

Standard Configuration ..... AR1850 **\$1,035**

### RRA LAR-15® CAR A4 - STANDARD CONFIGURATION

CALIBER	5.56mm NATO Chamber for 5.56mm & .223 Cal.	PISTOL GRIP	RRA Overmolded A2 Grip
LOWER RECEIVER	Forged RRA LAR-15®	BUTTSTOCK	RRA 6-Position Tactical CAR Stock
UPPER RECEIVER	Forged A4 Upper	HANDGUARD	CAR Length Handguard
BARREL	16 Inch Chrome Moly, 1:9 Twist / Gas Block Sight Base	WEIGHT / LENGTH	7.1 Pounds / 36 Inches
MUZZLE DEVICE	A2 Flash Hider / 1/2-28 Thread	ACCURACY	1 MOA at 100 yards
TRIGGER	RRA Two Stage	INCLUDED	One Mag, RRA Case, Manual, Warranty

## CAR A4 Complete Upper Halves

Includes Bolt Carrier Group and Charging Handle Assembly

### STANDARD CONFIGURATION

CALIBER	5.56mm NATO Chamber for 5.56mm & .223 Cal.
UPPER RECEIVER	Forged A4 Upper
BARREL	16 Inch Chrome Moly, 1:9 Twist / Gas Block Sight Base
MUZZLE DEVICE	A2 Flash Hider / 1/2-28 Thread
HANDGUARD	CAR Length Handguard



## CAR A4 Complete Upper Half

Standard Configuration ..... AR0328B **\$550**



*Shown with optional  
RRA Quad Rail Free Float*

# RRA LAR-15® CAR A4



*Shown with optional  
RRA Wraparound Half Quad,  
RRA Flip Front Sight Gas Block  
and RRA Operator CAR Stock*



*Shown with optional  
RRA Delta Quad Rail and  
RRA Tactical CAR Stock  
Rubber Buttpad*

**Add the RRA Tactical Mount**  
AR0125ASSY . . . \$150



**Add the RRA Dominator2 EOTech Mount**  
AR0125FASSY . . . \$150



*Shown with optional  
A2 Upper Receiver,  
A2 Front Sight Base,  
RRA Free Float Tube  
and ACE Skeleton Stock*

## POPULAR OPTIONS AND UPGRADES

Substitute A2 Upper Receiver for A4 Upper Receiver	<b>Add \$50</b>	Substitute Hogue Rubber or ERGO SureGrip Pistol Grip	<b>Add \$3</b>
Substitute R-4 Handguard for CAR Handguard	<b>Add \$7</b>	Substitute ERGO Tactical Deluxe Pistol Grip	<b>Add \$40</b>
Substitute RRA Aluminum Free Float Tube	<b>Add \$65</b>	Substitute RRA Entry Buttstock	<b>No Charge</b>
Substitute Hogue Free Float Tube	<b>Add \$100</b>	Substitute RRA Operator A2 Stock	<b>Add \$50</b>
Substitute RRA Delta Quad CAR Drop-In	<b>Add \$120</b>	Substitute ACE Skeleton Stock	<b>Add \$42.50</b>
Substitute RRA Quad Rail Free Float with 3 Rail Covers	<b>Add \$145</b>	Substitute RRA Operator CAR Stock	<b>Add \$50</b>
Substitute RRA Wraparound Half Quad with 3 Rail Covers	<b>Add \$160</b>	Substitute Green Furniture on Rifle	<b>Add \$10</b>
Substitute Chrome Lined 1:9 Twist Barrel	<b>Add \$40</b>	Substitute Green Furniture on Upper Half	<b>Add \$5</b>
Substitute Chrome Lined Lightweight 1:9 Twist Barrel	<b>Add \$40</b>	Substitute Chromed Bolt Carrier Group	<b>Add \$60</b>
Substitute A2 Front Sight Base	<b>No Charge</b>	Substitute RRA Two Stage Chrome Trigger	<b>Add \$35</b>
Substitute Low Profile Gas Block	<b>No Charge</b>	Substitute Badger Tactical Latch on Charging Handle	<b>Add \$23</b>
Substitute RRA Flip Front Sight Gas Block	<b>Add \$45</b>	Substitute BCM Gunfighter Charging Handle	<b>Add \$25</b>
Substitute Long A2 Flash Hider	<b>Add \$20</b>	Substitute PPI Gas Buster Charging Handle	<b>Add \$65</b>
Substitute Long A2 Flash Hider - Tactical	<b>Add \$25</b>	Substitute Ambidextrous Charging Handle	<b>Add \$30</b>
Substitute AWB RRA Tactical or Military Style Muzzle Brake	<b>Add \$35</b>	Substitute Ambidextrous Safety Selector	<b>Add \$25</b>
Substitute Smith Vortex Flash Hider - 5.56/.223	<b>Add \$57</b>	Substitute RRA Winter Trigger Guard	<b>Add \$10</b>

**COMPLETE OPTIONS & UPGRADES LISTING ON PAGES 4 & 5**





Mid-Length Gas System

# RRA LAR-15® Mid-Length A4



Mid-Length Gas System

RRA Overmolded A2 Grip

RRA Two Stage Trigger

RRA Tactical CAR Stock



*Shown with optional  
A2 Upper Receiver and  
A2 Front Sight Base*

## RRA LAR-15® Mid-Length A4

Standard Configuration ..... AR1855 \$1,035

### RRA LAR-15® MID-LENGTH A4 - STANDARD CONFIGURATION

CALIBER	5.56mm NATO Chamber for 5.56mm & .223 Cal.	PISTOL GRIP	RRA Overmolded A2 Grip
LOWER RECEIVER	Forged RRA LAR-15®	BUTTSTOCK	RRA 6-Position Tactical CAR Stock
UPPER RECEIVER	Forged A4 Upper	HANDGUARD	Mid-Length Handguard
BARREL	16 Inch Chrome Moly, 1:9 Twist / Gas Block Sight Base	WEIGHT / LENGTH	7.1 Pounds / 36 Inches
MUZZLE DEVICE	A2 Flash Hider / 1/2-28 Thread	ACCURACY	1 MOA at 100 yards
TRIGGER	RRA Two Stage	INCLUDED	One Mag, RRA Case, Manual, Warranty

## Mid-Length A4 Complete Upper Halves

**Includes Bolt Carrier Group and Charging Handle Assembly**

### STANDARD CONFIGURATION

CALIBER	5.56mm NATO Chamber for 5.56mm & .223 Cal.
UPPER RECEIVER	Forged A4 Upper
BARREL	16 Inch Chrome Moly, 1:9 Twist / Gas Block Sight Base
MUZZLE DEVICE	A2 Flash Hider / 1/2-28 Thread
HANDGUARD	Mid-Length Handguard



### Mid-Length A4 Complete Upper Half

Standard Configuration ..... AR0388B \$550



*Shown with optional  
RRA Quad Rail Free Float*



*Shown with optional  
RRA Half Quad Rail,  
RRA Flip Front Sight Gas Block  
and RRA Operator CAR Stock*

**RRA LAR-15®**  
**Mid-Length A4**



*Shown with optional  
A2 Upper Receiver,  
A2 Front Sight Base,  
RRA Aluminum Free Float  
Tube, A2 Buttstock  
and Hogue Grip*

**Add the RRA Tactical Mount**  
AR0125ASSY . . . \$150



*Shown with optional  
RRA Advanced Half Quad Rail  
and RRA Tactical CAR Stock  
Rubber Buttpad*

**Add the RRA Dominator2 EOTech Mount**  
AR0125FASSY . . . \$150



**POPULAR OPTIONS AND UPGRADES**

Substitute A2 Upper Receiver for A4 Upper Receiver	<b>Add \$50</b>	Substitute ERGO Tactical Deluxe Pistol Grip	<b>Add \$40</b>
Substitute RRA Aluminum Free Float Tube	<b>Add \$65</b>	Substitute RRA Entry Buttstock	<b>No Charge</b>
Substitute RRA Delta Quad Mid-Length Drop-In	<b>Add \$120</b>	Substitute RRA Operator A2 Stock	<b>Add \$50</b>
Substitute RRA Quad Rail Free Float with 3 Rail Covers	<b>Add \$155</b>	Substitute ACE Skeleton Stock	<b>Add \$42.50</b>
Substitute RRA Half Quad Free Float with 3 Rail Covers	<b>Add \$165</b>	Substitute RRA Operator CAR Stock	<b>Add \$50</b>
Substitute RRA Advanced Half Quad with 3 Rail Covers	<b>Add \$180</b>	Substitute CAR Dual Loop Receiver End Plate	<b>Add \$14</b>
Substitute RRA Wraparound Quad with 3 Rail Covers	<b>Add \$195</b>	Substitute Green Furniture on Rifle	<b>Add \$10</b>
Substitute Chrome Lined 1:9 Twist Barrel	<b>Add \$40</b>	Substitute Green Furniture on Upper Half	<b>Add \$5</b>
Substitute Chrome Lined Lightweight 1:9 Twist Barrel	<b>Add \$40</b>	Substitute Chromed Bolt Carrier Group	<b>Add \$60</b>
Substitute A2 Front Sight Base	<b>No Charge</b>	Substitute RRA Two Stage Chrome Trigger	<b>Add \$35</b>
Substitute Low Profile Gas Block	<b>No Charge</b>	Substitute Badger Tactical Latch on Charging Handle	<b>Add \$23</b>
Substitute RRA Flip Front Sight Gas Block	<b>Add \$45</b>	Substitute BCM Gunfighter Charging Handle	<b>Add \$25</b>
Substitute Long A2 Flash Hider	<b>Add \$20</b>	Substitute PPI Gas Buster Charging Handle	<b>Add \$65</b>
Substitute AWB RRA Tactical or Military Style Muzzle Brake	<b>Add \$35</b>	Substitute Ambidextrous Charging Handle	<b>Add \$30</b>
Substitute Smith Vortex Flash Hider - 5.56/.223	<b>Add \$57</b>	Substitute Ambidextrous Safety Selector	<b>Add \$25</b>
Substitute Hogue Rubber or ERGO SureGrip Pistol Grip	<b>Add \$3</b>	Substitute RRA Winter Trigger Guard	<b>Add \$10</b>

**COMPLETE OPTIONS & UPGRADES LISTING ON PAGES 4 & 5**



**RRA  
Overmolded  
A2 Grip**

**RRA  
Two Stage  
Trigger**

## RRA LAR-15® Standard A4



**Substitute a Stainless  
Steel 1:8 Twist Barrel** ..... \$70

### POPULAR OPTIONS AND UPGRADES

Substitute RRA Aluminum Free Float Tube	<b>Add \$65</b>
Substitute Hogue Free Float Tube	<b>Add \$125</b>
Substitute RRA Quad Rail Free Float with 3 Rail Covers	<b>Add \$185</b>
Substitute RRA Advanced Half Quad with 3 Rail Covers	<b>Add \$190</b>
Substitute Chrome Lined 1:9 Twist Barrel	<b>Add \$40</b>
Substitute Stainless Steel 1:8 Twist Barrel	<b>Add \$70</b>
Substitute RRA Flip Front Sight Gas Block	<b>Add \$80</b>
Substitute AWB RRA Tactical Muzzle Brake	<b>Add \$35</b>
Substitute Smith Vortex Flash Hider	<b>Add \$57</b>
Substitute Hogue Rubber Pistol Grip	<b>Add \$3</b>
Substitute RRA 6-Position Tactical CAR Stock	<b>Add \$5</b>
Substitute RRA Operator CAR Stock	<b>Add \$50</b>
Substitute RRA Operator A2 Stock	<b>Add \$50</b>
Substitute ACE Skeleton ARFX	<b>Add \$52.50</b>
Substitute Magpul PRS Stock	<b>Add \$230</b>

**COMPLETE OPTIONS & UPGRADES LISTING ON PAGES 4 & 5**

### What is a .223 Wylde Chamber?

The .223 Wylde chamber was designed as a match chambering for semi-automatic rifles. It will accommodate both .223 Rem and 5.56 NATO ammunition. It is relieved in the case body to aid in extraction and features a shorter throat for improved accuracy.

## RRA LAR-15® Standard A4

Standard Configuration ..... AR1288 **\$1,010**

### STANDARD CONFIGURATION

CALIBER	.223 Wylde Chamber for 5.56mm & .223 Cal.
LOWER RECEIVER	Forged RRA LAR-15®
UPPER RECEIVER	Forged A4 Upper
BARREL	20 Inch Chrome Moly HBAR, 1:9 Twist / A2 Front Sight Base
MUZZLE DEVICE	A2 Flash Hider / 1/2-28 Thread
TRIGGER	RRA Two Stage
PISTOL GRIP	RRA Overmolded A2 Pistol Grip
BUTTSTOCK	A2 Buttstock
HANDGUARD	A2 Handguard
WEIGHT / LENGTH	8.2 Pounds / 39.5 Inches
ACCURACY	1 MOA at 100 yds
INCLUDED	One Mag, RRA Case, Manual, Warranty

## Standard A4 Complete Upper Halves

**Includes Bolt Carrier Group and  
Charging Handle Assembly**

### STANDARD CONFIGURATION

CALIBER	.223 Wylde Chamber for 5.56mm & .223 Cal.
UPPER RECEIVER	Forged A4 Upper
FRONT SIGHT	A2 Front Sight Base
MUZZLE DEVICE	A2 Flash Hider / 1/2-28 Thread
HANDGUARD	A2 Handguard



## Standard A4 Complete Upper Half

With 20 Inch Chrome Moly HBAR, 1:9 Twist ..... AR0450B **\$540**



## Standard A4 Complete Upper Half

With 20 Inch Stainless Steel HBAR, 1:8 Twist ..... AR0451B **\$605**





Free Float Thermo Mold Handguard

Match Front & Rear Sights

Cryogenically Treated Air Gauged Heavy Match Stainless Steel Barrel

NM A2 AR1285

NM A4 AR1286 with NM Detachable Carry Handle

RRA Two Stage Chrome Trigger Group



NM A2 and NM A4 now come standard with RRA Chrome Bolt Carrier Group and RRA Two Stage Match Chrome Trigger Group!

# RRA LAR-15<sup>®</sup> NM A2 & NM A4

## RRA LAR-15<sup>®</sup> NM A2

Standard Configuration ..... AR1285 **\$1,335**

### STANDARD CONFIGURATION

CALIBER	.223 Wylde Chamber for 5.56mm & .223 Cal.
LOWER RECEIVER	Forged RRA LAR-15 <sup>®</sup>
UPPER RECEIVER	Forged A2 Upper
BARREL	20" Air Gauged Heavy Match Stainless Steel, 1:8 Twist, Cryo Treated
MUZZLE DEVICE	A2 Flash Hider / 1/2-28 Thread
TRIGGER	RRA Two Stage Match Chrome Trigger Group
PISTOL GRIP / BUTTSTOCK	A2 Pistol Grip / A2 Buttstock
HANDGUARD	Free Float, High Temp Thermo Mold, NM Sleeve
REAR SIGHT	Match 1/2 x 1/2 min, .040 Hooded Aperture
FRONT SIGHT	Match .050 Post
WEIGHT / LENGTH / ACCURACY	9.7 Pounds / 39.5 Inches / 3/4 MOA at 100 yds
INCLUDED	20 Round Mag, RRA Case, Manual, Warranty
Substitute 1/4 x 1/4 min on Match Rear Sight	<b>No Charge</b>
Substitute .030 Hooded Aperture on Match Rear Sight	<b>No Charge</b>

COMPLETE OPTIONS & UPGRADES LISTING ON PAGES 4 & 5

## RRA LAR-15<sup>®</sup> NM A4

Standard Configuration ..... AR1286 **\$1,415**

### STANDARD CONFIGURATION

CALIBER	.223 Wylde Chamber for 5.56mm & .223 Cal.
LOWER RECEIVER	Forged RRA LAR-15 <sup>®</sup>
UPPER RECEIVER	Forged A4 with <b>NM Detachable Carry Handle</b>
BARREL	20" Air Gauged Heavy Match Stainless Steel, 1:8 Twist, Cryo Treated
MUZZLE DEVICE	A2 Flash Hider / 1/2-28 Thread
TRIGGER	RRA Two Stage Match Chrome Trigger Group
PISTOL GRIP / BUTTSTOCK	A2 Pistol Grip / A2 Buttstock
HANDGUARD	Free Float, High Temp Thermo Mold, NM Sleeve
REAR SIGHT	Match 1/2 x 1/2 min, .040 Hooded Aperture
FRONT SIGHT	Match .050 Post
WEIGHT / LENGTH / ACCURACY	9.7 Pounds / 39.5 Inches / 3/4 MOA at 100 yds
INCLUDED	20 Round Mag, RRA Case, Manual, Warranty
Substitute 1/4 x 1/4 min on Match Rear Sight	<b>No Charge</b>
Substitute .030 Hooded Aperture on Match Rear Sight	<b>No Charge</b>

COMPLETE OPTIONS & UPGRADES LISTING ON PAGES 4 & 5

# NM A2 & NM A4 Complete Upper Halves



NM A2 Complete Upper Half ..... AR0775B **\$815**



NM A4 Complete Upper Half ..... AR0790B **\$765**

Includes Chrome Bolt Carrier Group.  
Includes Charging Handle Assembly.

### STANDARD CONFIGURATION

CALIBER	.223 Wylde Chamber for 5.56mm & .223 Cal.
UPPER RECEIVER	Forged A2 or Forged A4 Upper
BARREL	20" Heavy Match Stainless Steel, 1:8 Twist, Cryo Treated
MUZZLE DEVICE	A2 Flash Hider / 1/2-28 Thread
HANDGUARD	Free Float, High Temp Thermo Mold, NM Sleeve
REAR SIGHT	A2 only: Match 1/2 x 1/2 min, .040 Hooded Aperture
FRONT SIGHT	Match .050 Post

ADD NM CARRY HANDLE TO A4 UPPER HALF **\$165**

RRA LAR-15<sup>®</sup> 5.56MM / .223

**A2 Stock**

**24 Inch AR1550**



**Hogue Grip**

**NEW LOOK FOR 2013!**  
New RRA TRO Free Float Handguard  
**TRO - Top Rail Octagonal**  
over Low Profile Gas Block

**Cryogenically Treated**  
**Air Gauged Stainless**  
**Steel Bull Barrel**



*Shown with optional RRA Operator A2 Stock*

**RRA Two Stage Match Trigger**  
and **RRA Winter Trigger Guard**

**18 Inch AR1515**

**RRA LAR-15® Varmint A4**

- Varmint A4 - 16 Inch 1:8 Twist Barrel ..... AR1500 **\$1,215**
- Varmint A4 - 18 Inch 1:8 Twist Barrel ..... AR1515 **\$1,230**
- Varmint A4 - 20 Inch 1:8 Twist Barrel ..... AR1520 **\$1,245**
- Varmint A4 - 24 Inch 1:8 Twist Barrel ..... AR1550 **\$1,255**
- Varmint A4 - 24 Inch 1:12 Twist Barrel ..... AR1551 **\$1,255**

**POPULAR OPTIONS AND UPGRADES**

Substitute RRA TRO-Mid Handguard on 16 Inch Varmint	<b>Add \$10</b>
Substitute RRA TRO-Std Handguard on 16 Inch Varmint	<b>Add \$20</b>
Substitute RRA TRO-XL Handguard on 16 Inch Varmint	<b>Add \$35</b>
Substitute RRA TRO-Std Handguard on 18 Inch Varmint	<b>Add \$10</b>
Substitute RRA TRO-XL Handguard on 18 Inch Varmint	<b>Add \$25</b>
Substitute RRA TRO-XL Handguard on 20 or 24 Inch Varmint	<b>Add \$15</b>
Substitute RRA Operator A2 Stock	<b>Add \$50</b>
Substitute Magpul PRS Stock	<b>Add \$230</b>
Substitute Chromed Bolt Carrier Group	<b>Add \$60</b>
Substitute RRA Two Stage Chrome Trigger	<b>Add \$35</b>
Bead Blast Stainless Steel Barrel	<b>Add \$35</b>

**COMPLETE OPTIONS & UPGRADES LISTING ON PAGES 4 & 5**

**RRA LAR-15®**  
**Varmint A4**

**STANDARD CONFIGURATION**

CALIBER	.223 Wylde Chamber for 5.56mm & .223 Cal.	
LOWER RECEIVER	Forged RRA LAR-15®	
UPPER RECEIVER	Forged A4 Upper	
BARREL	Air Gauged Stainless Steel Bull, 1:8 Twist, Cryo Treated	
BARREL DIAMETER	.920 in front of gas block - 1.050 under tube	
GAS BLOCK	Low Profile Gas Block	
TRIGGER	RRA Two Stage Match	
TRIGGER GUARD	RRA Winter Trigger Guard	
HANDGUARD	RRA TRO Free Float - Top Rail Octagonal	
PISTOL GRIP	Hogue Rubber	
BUTTSTOCK	A2 Buttstock	
WEIGHT / LENGTH	16 INCH	8.0 Pounds / 34.25 Inches
	18 INCH	8.7 Pounds / 36.25 Inches
	20 INCH	9.4 Pounds / 38.25 Inches
	24 INCH	10.2 Pounds / 42.25 Inches
ACCURACY	3/4 MOA at 100 Yards	
INCLUDED	One Mag, RRA Case, Manual, Warranty	

**Varmint A4 Complete Upper Halves**

**Includes Bolt Carrier Group and Charging Handle Assembly**

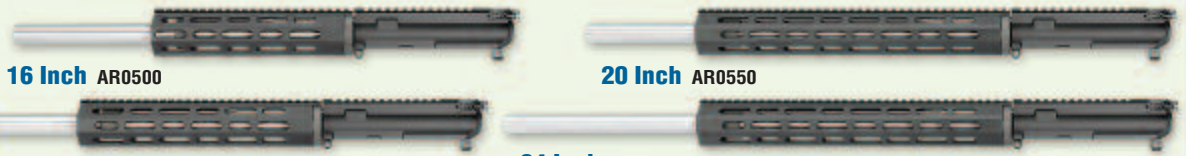

**16 Inch AR0500**

**20 Inch AR0550**

**18 Inch AR0525**

**24 Inch AR0575**

**STANDARD CONFIGURATION**

CALIBER	.223 Wylde Chamber for 5.56mm & .223 Cal.	
UPPER RECEIVER	Forged A4 Upper	
BARREL	Air Gauged Stainless Steel Bull, 1:8 Twist, Cryo Treated	
BARREL DIAMETER	.920 in front of gas block - 1.050 under tube	
GAS BLOCK	Low Profile Gas Block	
HANDGUARD	RRA TRO Free Float - Top Rail Octagonal	

**Varmint A4 Complete Upper Halves**

- Varmint A4 - 16 Inch 1:8 Twist Barrel ..... AR0500 **\$700**
- Varmint A4 - 18 Inch 1:8 Twist Barrel ..... AR0525 **\$715**
- Varmint A4 - 20 Inch 1:8 Twist Barrel ..... AR0550 **\$730**
- Varmint A4 - 24 Inch 1:8 Twist Barrel ..... AR0575 **\$740**
- Varmint A4 - 24 Inch 1:12 Twist Barrel ..... AR0576 **\$740**

20 Inch AR1525

A2 Stock

Cryogenically Treated  
Air Gauged Stainless  
Steel Bull Barrel

NEW LOOK FOR 2013!  
New RRA TRO Free Float Handguard  
TRO - Top Rail Octagonal  
over Low Profile Gas Block

Hogue  
Grip

16 Inch AR1505

RRA Two Stage Match Trigger  
and RRA Winter Trigger Guard

Shown with  
optional RRA  
Operator CAR Stock

# RRA LAR-15® Varmint EOP

## STANDARD CONFIGURATION

CALIBER	.223 Wylde Chamber for 5.56mm & .223 Cal.	
LOWER RECEIVER	Forged RRA LAR-15®	
UPPER RECEIVER	Forged EOP - Elevated Optical Platform	
BARREL	Air Gauged Stainless Steel Bull, 1:8 Twist, Cryo Treated	
BARREL DIAMETER	.920 in front of gas block - 1.050 under tube	
GAS BLOCK	Low Profile Gas Block	
TRIGGER	RRA Two Stage Match	
TRIGGER GUARD	RRA Winter Trigger Guard	
HANDGUARD	RRA TRO Free Float - Top Rail Octagonal	
PISTOL GRIP	Hogue Rubber	
BUTTSTOCK	A2 Buttstock	
WEIGHT / LENGTH	16 INCH	8.2 Pounds / 34.25 Inches
	18 INCH	8.9 Pounds / 36.25 Inches
	20 INCH	9.6 Pounds / 38.25 Inches
	24 INCH	10.4 Pounds / 42.25 Inches
ACCURACY	3/4 MOA at 100 Yards	
INCLUDED	One Mag, RRA Case, Manual, Warranty	

## EOP - Elevated Optical Platform Upper Receiver

With 3/4 inch taller rail  
height than  
standard  
A4 uppers.

## RRA LAR-15® Varmint EOP

- Varmint EOP - 16 Inch 1:8 Twist Barrel..... AR1505 **\$1,250**
- Varmint EOP - 18 Inch 1:8 Twist Barrel..... AR1516 **\$1,265**
- Varmint EOP - 20 Inch 1:8 Twist Barrel..... AR1525 **\$1,280**
- Varmint EOP - 24 Inch 1:8 Twist Barrel..... AR1555 **\$1,290**
- Varmint EOP - 24 Inch 1:12 Twist Barrel..... AR1556 **\$1,290**

## POPULAR OPTIONS AND UPGRADES

Substitute Chromed Bolt Carrier Group	<b>Add \$60</b>
Substitute RRA Two Stage Chrome Trigger	<b>Add \$35</b>
Substitute RRA Operator CAR Stock	<b>Add \$50</b>

COMPLETE OPTIONS & UPGRADES LISTING ON PAGES 4 & 5

# Varmint EOP Complete Upper Halves

Includes Bolt Carrier Group and Charging Handle Assembly

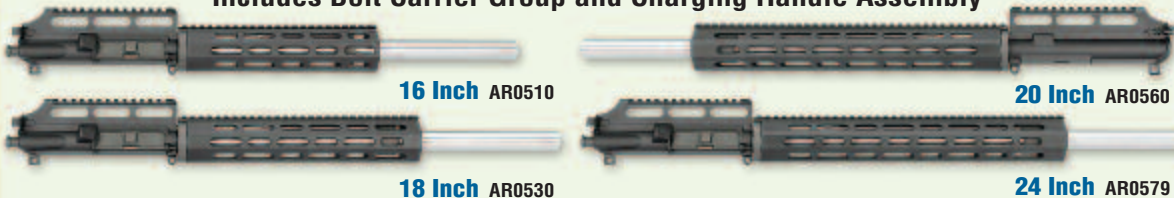

16 Inch AR0510

20 Inch AR0560

18 Inch AR0530

24 Inch AR0579

## Varmint EOP Complete Upper Halves

- Varmint EOP - 16 Inch 1:8 Twist Barrel..... AR0510 **\$725**
- Varmint EOP - 18 Inch 1:8 Twist Barrel..... AR0530 **\$740**
- Varmint EOP - 20 Inch 1:8 Twist Barrel..... AR0560 **\$755**
- Varmint EOP - 24 Inch 1:8 Twist Barrel..... AR0579 **\$765**
- Varmint EOP - 24 Inch 1:12 Twist Barrel..... AR0580 **\$765**

## STANDARD CONFIGURATION

CALIBER	.223 Wylde Chamber for 5.56mm & .223 Cal.	
UPPER RECEIVER	Forged EOP - Elevated Optical Platform	
BARREL	Air Gauged Stainless Steel Bull, 1:8 Twist, Cryo Treated	
BARREL DIAMETER	.920 in front of gas block - 1.050 under tube	
GAS BLOCK	Low Profile Gas Block	
HANDGUARD	RRA TRO Free Float - Top Rail Octagonal	



RRA LAR-15® 5.56MM / .223



**Cryogenically Treated  
16 Inch Air Gauged Heavy  
Match Stainless Steel Barrel**

**RRA Aluminum  
Free Float Tube  
Mid-Length Gas System**

**RRA  
Two Stage  
Match Trigger  
and Winter Trigger Guard**

**Hogue  
Grip**

# RRA LAR-15® Predator Pursuit™ Mid-Length



*Shown with optional EOP Upper Receiver  
and RRA Operator A2 Stock*

## RRA LAR-15® Predator Pursuit™ Mid-Length

**Standard Configuration . . . . . AR1545 \$1,190**

### STANDARD CONFIGURATION

CALIBER	.223 Wylde Chamber for 5.56mm & .223 Cal.
LOWER RECEIVER	Forged RRA LAR-15®
UPPER RECEIVER	Forged A4 Upper
BARREL	16" Air Gauged Heavy Match Stainless Steel, 1:8 Twist, Cryo Treated
GAS BLOCK	Light Varmint Gas Block with Sight Rail
TRIGGER	RRA Two Stage Match
TRIGGER GUARD	RRA Winter Trigger Guard
HANDGUARD	RRA Aluminum Free Float Tube, Mid-Length
PISTOL GRIP	Hogue Rubber Grip
BUTTSTOCK	A2 Buttstock
WEIGHT / LENGTH	7.2 Pounds / 34.25 Inches
ACCURACY	3/4 MOA at 100 Yards
INCLUDED	One Mag, RRA Case, Manual, Warranty

### Predator Pursuit™ or Varmint Rifle?

The Predator Pursuit™ Mid-Length has all the great features of our Varmint rifle, but with a 16 inch Heavy Match Stainless Steel Barrel, the same diameter barrel used on our NM rifles, in place of the Varmint rifle's Bull Barrel. The result is a highly accurate rifle that's over 1/2 pound lighter than the 16 inch Varmint.

### POPULAR OPTIONS AND UPGRADES

Substitute RRA Quad Rail with 3 Rail Covers	<b>Add \$75</b>
Substitute RRA Half Quad with 3 Rail Covers	<b>Add \$95</b>
Substitute EOP Upper Receiver	<b>Add \$20</b>
Bead Blast Stainless Steel Barrel	<b>Add \$35</b>
Substitute Low Profile Gas Block	<b>No Charge</b>
Substitute RRA Operator A2 Stock	<b>Add \$50</b>
Substitute Chromed Bolt Carrier Group	<b>Add \$60</b>
Substitute RRA Two Stage Chrome Trigger	<b>Add \$35</b>
Substitute Ambidextrous Charging Handle	<b>Add \$30</b>
Substitute Ambidextrous Safety Selector	<b>Add \$25</b>
Substitute Ambidextrous Mag Catch	<b>Add \$88</b>

**COMPLETE OPTIONS & UPGRADES LISTING ON PAGES 4 & 5**

## Predator Pursuit™ Mid-Length Complete Upper Half

**Includes Bolt Carrier Group and Charging Handle Assembly**

### STANDARD CONFIGURATION

CALIBER	.223 Wylde Chamber for 5.56mm & .223 Cal.
UPPER RECEIVER	Forged A4 Upper
BARREL	16" Heavy Match Stainless Steel, 1:8 Twist, Cryo Treated
GAS BLOCK	Light Varmint Gas Block with Sight Rail
HANDGUARD	RRA Aluminum Free Float Tube, Mid-Length



### Predator Pursuit™ Mid-Length Complete Upper Half

**Standard Configuration . . . . . AR0570 \$675**



Hogue Grip

RRA Two Stage Match Trigger and Winter Trigger Guard

RRA Aluminum Free Float Tube Rifle Length Gas System

Cryogenically Treated 20 Inch Air Gauged Heavy Match Stainless Steel Barrel

# RRA LAR-15® Predator Pursuit™ Rifle



Shown with optional Hogue Free Float Tube

## Predator Pursuit™ or Varmint Rifle?

The Predator Pursuit Rifle has all the great features of our Varmint rifle, but with a 20 inch Heavy Match Stainless Steel Barrel, the same barrel used on our NM rifles, in place of the Varmint rifle's Bull Barrel. The result is a highly accurate rifle that's over one pound lighter than the 20 inch Varmint Rifle.

## POPULAR OPTIONS AND UPGRADES

Substitute Hogue Free Float Tube	Add \$60
Substitute RRA Quad Rail with 3 Rail Covers	Add \$100
Substitute RRA Advanced Half Quad Rail w/ 3 Rail Covers	Add \$120
Substitute Green Furniture on 20" Predator Pursuit, with Green Hogue Free Float Tube, Green Hogue Grip and Green A2 Buttstock	Add \$70
Substitute EOP Upper Receiver	Add \$20
Bead Blast Stainless Steel Barrel	Add \$35
Substitute RRA Operator A2 Stock	Add \$50
Substitute Magpul PRS Stock	Add \$230
Substitute Chromed Bolt Carrier Group	Add \$60
Substitute RRA Two Stage Chrome Trigger	Add \$35
Substitute Ambidextrous Charging Handle	Add \$30

COMPLETE OPTIONS & UPGRADES LISTING ON PAGES 4 & 5

## RRA LAR-15® Predator Pursuit™ Rifle

Standard Configuration ..... AR1530 **\$1,190**

### STANDARD CONFIGURATION

CALIBER	.223 Wylde Chamber for 5.56mm & .223 Cal.
LOWER RECEIVER	Forged RRA LAR-15®
UPPER RECEIVER	Forged A4 Upper
BARREL	20" Air Gauged Heavy Match Stainless Steel, 1:8 Twist, Cryo Treated
GAS BLOCK	Light Varmint Gas Block with Sight Rail
TRIGGER	RRA Two Stage Match
TRIGGER GUARD	RRA Winter Trigger Guard
HANDGUARD	RRA Aluminum Free Float Tube, Rifle Length
PISTOL GRIP	Hogue Rubber Grip
BUTTSTOCK	A2 Buttstock
WEIGHT / LENGTH	8.1 Pounds / 38.25 Inches
ACCURACY	3/4 MOA at 100 Yards
INCLUDED	One Mag, RRA Case, Manual, Warranty

RRA LAR-15® 5.56MM / .223

## Predator Pursuit™ Rifle Complete Upper Half

Includes Bolt Carrier Group and Charging Handle Assembly

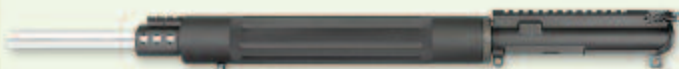

## Predator Pursuit™ Rifle Complete Upper Half

Standard Configuration ..... AR0565 **\$675**

### STANDARD CONFIGURATION

CALIBER	.223 Wylde Chamber for 5.56mm & .223 Cal.
UPPER RECEIVER	Forged A4 Upper
BARREL	20" Heavy Match Stainless Steel, 1:8 Twist, Cryo Treated
GAS BLOCK	Light Varmint Gas Block with Sight Rail
HANDGUARD	RRA Aluminum Free Float Tube, Rifle Length

RRA LAR-15® 5.56MM / .223



20 Inch Chrome Moly HBAR  
with Smith Vortex Flash Hider

Hogue Free Float Tube  
Rifle Length Gas System

RRA Operator  
A2 Stock

Hogue  
Grip

RRA  
Two Stage  
Match Trigger  
and Winter Trigger Guard

# RRA LAR-15® Coyote Rifle



RRA Operator  
A2 Stock

Hogue  
Grip

RRA  
Two Stage  
Match Trigger and  
Winter Trigger Guard

Hogue Free Float Tube  
CAR Length Gas System

16 Inch Chrome Moly HBAR  
with Smith Vortex Flash Hider

# RRA LAR-15® Coyote Carbine

## RRA LAR-15® Coyote Rifle

With 20 Inch Barrel ..... AR1535 **\$1,305**

### STANDARD CONFIGURATION

CALIBER	.223 Wylde Chamber for 5.56mm & .223 Cal.
LOWER / UPPER RECEIVER	Forged RRA LAR-15® Lower / Forged A4 Upper
BARREL	20 Inch Chrome Moly HBAR, 1:9 Twist
MUZZLE DEVICE	Smith Vortex Flash Hider / 1/2-28 Thread
GAS BLOCK	Light Varmint Gas Block with Sight Rail
TRIGGER / TRIGGER GUARD	RRA Two Stage Match / Winter Trigger Guard
PISTOL GRIP / BUTTSTOCK	Hogue Rubber Grip / RRA Operator A2 Stock
HANDGUARD	Hogue Overmolded Free Float Tube, Rifle Length
WEIGHT / LENGTH / ACCURACY	8.4 Pounds / 40 Inches / 3/4 MOA at 100 yds
INCLUDED	One Mag, RRA Case, Manual, Warranty

### POPULAR OPTIONS AND UPGRADES

Substitute EOP Upper Receiver	<b>Add \$20</b>
Substitute RRA Quad Rail Free Float with 3 Rail Covers	<b>Add \$100</b>
Substitute RRA Flip Front Sight Gas Block	<b>Add \$45</b>

COMPLETE OPTIONS & UPGRADES LISTING ON PAGES 4 & 5

## RRA LAR-15® Coyote Carbine

With 16 Inch Barrel ..... AR1540 **\$1,255**

### STANDARD CONFIGURATION

CALIBER	5.56mm NATO Chamber for 5.56mm & .223 Cal.
LOWER / UPPER RECEIVER	Forged RRA LAR-15® Lower / Forged A4 Upper
BARREL	16 Inch Chrome Moly HBAR, 1:9 Twist
MUZZLE DEVICE	Smith Vortex Flash Hider / 1/2-28 Thread
GAS BLOCK	Light Varmint Gas Block with Sight Rail
TRIGGER / TRIGGER GUARD	RRA Two Stage Match / Winter Trigger Guard
PISTOL GRIP / BUTTSTOCK	Hogue Rubber Grip / RRA Operator A2 Stock
HANDGUARD	Hogue Overmolded Free Float Tube, CAR Length
WEIGHT / LENGTH / ACCURACY	7.0 Pounds / 36 Inches / 3/4 MOA at 100 yds
INCLUDED	One Mag, RRA Case, Manual, Warranty

### POPULAR OPTIONS AND UPGRADES

Substitute RRA Quad Rail Free Float with 3 Rail Covers	<b>Add \$40</b>
Substitute Ambidextrous Safety Selector	<b>Add \$25</b>
Substitute Ambidextrous Mag Catch	<b>Add \$88</b>

COMPLETE OPTIONS & UPGRADES LISTING ON PAGES 4 & 5

# Coyote Rifle & Carbine Complete Upper Halves



## Coyote Rifle Complete Upper Half

With 20 Inch Barrel ..... AR0585 **\$745**



## Coyote Carbine Complete Upper Half

With 16 Inch Barrel ..... AR0590 **\$695**

Includes Bolt Carrier Group and  
Charging Handle Assembly

### STANDARD CONFIGURATION

CALIBER : RIFLE	.223 Wylde Chamber for 5.56mm & .223 Cal.
CALIBER : CARBINE	5.56mm NATO Chamber for 5.56 & .223 Cal.
UPPER RECEIVER	Forged A4 Upper
BARREL	Chrome Moly HBAR, 1:9 Twist
MUZZLE DEVICE	Smith Vortex Flash Hider / 1/2-28 Thread
GAS BLOCK	Light Varmint Gas Block with Sight Rail
HANDGUARD	Hogue Overmolded Free Float Tube



**RRA Tactical Muzzle Brake**

**Low Profile Gas Block**

**RRA Operator CAR Stock**

**Cryogenically Treated 18 Inch Heavy Match Stainless Steel Barrel**

**RRA Advanced Half Quad Free Float Mid-Length Handguard**

Advanced Half Quad Handguard style may vary from picture

**ERGO SureGrip**

**RRA Two Stage Trigger and Winter Trigger Guard**

# RRA LAR-15® ATH Carbine Advanced Tactical Hunter



**AWB Compliant AR1565**  
*AWB Compliant model shown with RRA Operator A2 Stock, no muzzle device*

## STANDARD CONFIGURATION

CALIBER	.223 Wylde Chamber for 5.56mm & .223 Cal.
LOWER RECEIVER	Forged RRA LAR-15®
UPPER RECEIVER	Forged A4 Upper
BARREL	18 Inch Heavy Match Stainless Steel, 1:8 Twist, Cryo Treated
MUZZLE DEVICE	RRA Tactical Muzzle Brake / 1/2-28 Thread
GAS BLOCK	Low Profile Gas Block
TRIGGER	RRA Two Stage
TRIGGER GUARD	RRA Winter Trigger Guard
SAFETY SELECTOR	Star Safety
PISTOL GRIP	ERGO SureGrip
HANDGUARD	RRA Advanced Half Quad Free Float with 3 Rail Covers
BUTTSTOCK	RRA Operator CAR Stock
WEIGHT	7.6 Pounds
LENGTH	39 Inches
ACCURACY	3/4 MOA at 100 Yards
INCLUDED	One Mag, RRA Case, Manual, Warranty

## RRA LAR-15® ATH Carbine

Standard Configuration	AR1560	\$1,370
AWB Compliant	AR1565	\$1,335

## POPULAR OPTIONS AND UPGRADES

Substitute RRA TRO-Std or TRO-XL Handguard	No Charge
Substitute Smith Vortex Flash Hider for Tactical Brake	Add \$30
Bead Blast Stainless Steel Barrel	Add \$35
Substitute Chromed Bolt Carrier Group	Add \$60
Substitute RRA Two Stage Chrome Trigger	Add \$35
Substitute Badger Tactical Latch on Charging Handle	Add \$23
Substitute BCM Gunfighter Charging Handle	Add \$25
Substitute PRI Gas Buster Charging Handle	Add \$65
Substitute Ambidextrous Charging Handle	Add \$30
Substitute Ambidextrous Safety Selector	Add \$25
Substitute Ambidextrous Mag Catch	Add \$88

**COMPLETE OPTIONS & UPGRADES LISTING ON PAGES 4 & 5**

# ATH Carbine Complete Upper Half

**Includes Bolt Carrier Group and Charging Handle Assembly**



## ATH Carbine Complete Upper Half

Standard Configuration ..... AR0595 **\$830**

## STANDARD CONFIGURATION

CALIBER	.223 Wylde Chamber for 5.56mm & .223 Cal.
UPPER RECEIVER	Forged A4 Upper
BARREL	18" Heavy Match Stainless, 1:8 Twist, Cryo Treated
MUZZLE DEVICE	RRA Tactical Muzzle Brake / 1/2-28 Thread
HANDGUARD	RRA Advanced Half Quad with 3 Rail Covers

RRA LAR-15® 5.56MM / .223

RRA LAR-15® 5.56MM / .223



Hogue Grip

RRA Two Stage Trigger

RRA Half Quad Free Float Mid-Length Handguard

Half Quad Handguard style may vary from picture

MI QD Sling Adapter

RRA Tactical Muzzle Brake

WYL-Ehide® Camo Finish



CAR Length Gas System Low Profile Gas Block

PRK-Ehide® Camo Finish

RRA Operator CAR Stock

RRA LAR-15®

# Hunter

Featuring RRA's new camo finishes!

The finishes are digitalized imagery of real wild hog - PRK-Ehide® and coyote - WYL-Ehide®, and in the hardcoat anodizing, not a film dip or applique. The camo is anodized to the lower receiver, upper receiver, charging handle, trigger guard and handguard.



WYL-Ehide®

© ®



PRK-Ehide®

© ®

## RRA LAR-15® Hunter

With WYL-Ehide® Finish ..... WH1000 \$1,550

## RRA LAR-15® Hunter

With PRK-Ehide® Finish ..... PH1000 \$1,550

### RRA LAR-15® HUNTER - STANDARD CONFIGURATION

CALIBER	5.56mm NATO Chamber for 5.56mm & .223 Cal.	SAFETY SELECTOR	Star Safety
LOWER RECEIVER	Forged RRA LAR-15®	HANDGUARD	RRA Half Quad Free Float Mid-Length with 3 Rail Covers
UPPER RECEIVER	Forged A4 Upper	BUTTSTOCK	RRA Operator CAR Stock
BARREL	16 Inch Chrome Moly, 1:9 Twist	PISTOL GRIP	Hogue Rubber
MUZZLE DEVICE	RRA Tactical Muzzle Brake / 1/2-28 Thread	WEIGHT / LENGTH	7.6 Pounds / 37 Inches
GAS BLOCK	Low Profile Gas Block	ACCURACY	3/4 MOA at 100 Yards
TRIGGER	RRA Two Stage / RRA Winter Trigger Guard	INCLUDED	One Mag, RRA Case, Manual, Warranty





**THE FOOD CHAIN ENDS HERE.**



**RRA Operator A2 Stock**

**Hogue Rubber Grip**

**RRA Chrome Two Stage Trigger with Non-reflective Surface on Trigger Shoe**

**RRA Fred Eichler Series Free Float Handguard with Full Length Top Rail and 2.5 inch Rail at 3, 6 and 9 o'clock**

**Cryogenically Treated Bead Blasted Stainless Steel Barrel**

**Badger Tactical Latch**

**RRA Tuned and Ported Muzzle Brake**

**Mid-Length Gas System with Low Profile Gas Block**

**RRA Winter Trigger Guard**

**RRA Operator CAR Stock**

**RRA LAR-15® FRED EICHLER SERIES**

**RRA LAR-15® Fred Eichler Series Predator**

- With RRA Operator A2 Stock . . . . . FE1000 **\$1,510**
  - With RRA Operator CAR Stock . . . . . FE1015 **\$1,510**
  - AWB Compliant . . . . . FE1001 **\$1,470**
- AWB Compliant Model has crowned barrel without muzzle device

**RRA LAR-15® FRED EICHLER SERIES PREDATOR - STANDARD CONFIGURATION**

CALIBER	.223 Wylde Chamber for 5.56mm & .223 Cal.	SAFETY SELECTOR	Star Safety
LOWER RECEIVER	Forged RRA LAR-15®	HANDGUARD	RRA Fred Eichler Series Free Float with 3 Rail Covers
UPPER RECEIVER	Forged A4 Upper	PISTOL GRIP	Hogue Rubber, Tan
BARREL	16 Inch Bead Blasted Stainless Steel, 1:8 Twist, Cryo Treated	WITH OPER A2 STOCK : WEIGHT / LENGTH	7.6 Pounds / 36 Inches
MUZZLE	RRA Directionally-Tuned and Ported Brake / 1/2-28 Thread	WITH OPER CAR STOCK : WEIGHT / LENGTH	7.6 lbs / 34 Inches Retracted
GAS BLOCK	Low Profile Gas Block	ACCURACY	3/4 MOA at 100 Yards
TRIGGER	RRA Chrome Two Stage / RRA Winter Trigger Guard	INCLUDED	One Mag, RRA Case, Manual, Warranty

**RRA LAR-15® 5.56MM / .223**



# RRA LAR-15® 7 Inch A4 Pistol



**RRA Aluminum Free Float Tube**

**Hogue Grip**



*Shown with optional  
RRA Quad Rail Free Float*



*Shown with optional  
A2 Upper Receiver and  
A2 Front Sight Base*

**All NFA rules apply.**

## RRA LAR-15® 7 Inch A4 Pistol

Standard Configuration . . . . . AR2110 **\$1,060**

### STANDARD CONFIGURATION

CALIBER	5.56mm NATO Chamber for 5.56mm & .223 Cal.
LOWER RECEIVER	Forged RRA LAR-15®
UPPER RECEIVER	Forged A4 Upper
BARREL	7 Inch Chrome Moly, 1:9 Twist / Gas Block Sight Base
MUZZLE DEVICE	A2 Flash Hider / 1/2-28 Thread
TRIGGER	Single Stage
PISTOL GRIP	Hogue Rubber Grip
HANDGUARD	RRA Aluminum Free Float Tube, Pistol Length
WEIGHT / LENGTH	5.0 Pounds / 23 Inches
INCLUDED	One Mag, Manual, Warranty

### POPULAR OPTIONS AND UPGRADES

Substitute A2 Upper Receiver	<b>Add \$50</b>
Substitute A2 Front Sight Base	<b>No Charge</b>
Substitute RRA Quad Rail Free Float with 3 Rail Covers	<b>Add \$75</b>
Substitute Low Profile Gas Block	<b>No Charge</b>
Substitute RRA Flip Front Sight Gas Block	<b>Add \$45</b>
Substitute Chromed Bolt Carrier Group	<b>Add \$60</b>
Substitute PRI Gas Buster Charging Handle	<b>Add \$65</b>
Substitute Ambidextrous Charging Handle	<b>Add \$30</b>
Substitute Ambidextrous Safety Selector	<b>Add \$25</b>
Substitute RRA Winter Trigger Guard	<b>Add \$10</b>

**COMPLETE OPTIONS & UPGRADES LISTING ON PAGES 4 & 5**

# 7 Inch A4 Pistol Complete Upper Half

**For Pistol and SBR applications only - all NFA rules apply.**

**Includes Bolt Carrier Group and Charging Handle Assembly**

### STANDARD CONFIGURATION

CALIBER	5.56mm NATO Chamber for 5.56mm & .223 Cal.
UPPER RECEIVER	Forged A4 Upper
BARREL	7 Inch Chrome Moly, 1:9 Twist
MUZZLE DEVICE	A2 Flash Hider / 1/2-28 Thread
GAS BLOCK	Gas Block Sight Base
HANDGUARD	RRA Aluminum Free Float Tube, Pistol Length



## 7 Inch A4 Pistol Complete Upper Half

Standard Configuration . . . . . AR0363B **\$605**

All NFA rules apply.



Hogue Grip

# RRA LAR-15® 10.5 Inch A4 Pistol



Shown with optional RRA Quad Rail Free Float, RRA Flip Front Sight Gas Block and RRA Stand Alone Rear Sight



Shown with optional RRA Aluminum Free Float Tube

## POPULAR OPTIONS AND UPGRADES

Substitute Chrome Lined 1:7 Twist Barrel	Add \$40
Substitute RRA Aluminum Free Float Tube	Add \$65
Substitute Hogue Free Float Tube	Add \$100
Substitute RRA Quad Rail Free Float with 3 Rail Covers	Add \$145
Substitute Low Profile Gas Block	No Charge
Substitute RRA Flip Front Sight Gas Block	Add \$45
Substitute Chromed Bolt Carrier Group	Add \$60
Substitute Ambidextrous Mag Catch	Add \$88
Substitute Ambidextrous Safety Selector	Add \$25
Substitute RRA Winter Trigger Guard	Add \$10

COMPLETE OPTIONS & UPGRADES LISTING ON PAGES 4 & 5

## RRA LAR-15® 10.5 Inch A4 Pistol

Standard Configuration ..... AR2120 **\$1,015**

### STANDARD CONFIGURATION

CALIBER	5.56mm NATO Chamber for 5.56mm & .223 Cal.
LOWER RECEIVER	Forged RRA LAR-15®
UPPER RECEIVER	Forged A4 Upper
BARREL	10.5 Inch Chrome Moly, 1:7 Twist / Gas Block Sight Base
MUZZLE DEVICE	A2 Flash Hider / 1/2-28 Thread
TRIGGER	Single Stage
PISTOL GRIP	Hogue Rubber Grip
HANDGUARD	R-4 Handguard
WEIGHT / LENGTH	5.2 Pounds / 26.5 Inches
INCLUDED	One Mag, Manual, Warranty

RRA LAR-15® 5.56MM / .223

# 10.5 Inch A4 Pistol Complete Upper Half

For Pistol and SBR applications only - all NFA rules apply.

Includes Bolt Carrier Group and Charging Handle Assembly



## 10.5 Inch A4 Pistol Complete Upper Half

Standard Configuration ..... AR0362B **\$560**

### STANDARD CONFIGURATION

CALIBER	5.56mm NATO Chamber for 5.56mm & .223 Cal.
UPPER RECEIVER	Forged A4 Upper
BARREL	10.5 Inch Chrome Moly, 1:7 Twist
MUZZLE DEVICE	A2 Flash Hider / 1/2-28 Thread
GAS BLOCK	Gas Block Sight Base
HANDGUARD	R-4 Handguard

# LAR-PDS® - Piston Driven System

ROCK RIVER ARMS PISTON DRIVEN SYSTEM



## Rock River Arms LAR-PDS® Pistol Piston Driven System



The **RRA LAR-PDS® Pistol** is the first of a new generation of firearms employing RRA's patent-pending **Piston Driven System (PDS)**. Featuring a purpose-designed bolt carrier, an adjustable gas piston and an over-the-barrel spring and guide rod arrangement, the LAR-PDS® is able to completely do away with the traditional recoil system associated with AR-style firearms, making for an extremely versatile weapon platform. Several exciting new models are scheduled for release in 2013, as well as specialized parts and accessories.

**RRA LAR-PDS® Pistol** with LAR-PDS® Injection Molded Ribbed Handguard..... LP2110 **\$1,245**  
**RRA LAR-PDS® Pistol** with LAR-PDS® Aluminum Tri-Rail Handguard ..... LP2113 **\$1,395**

RRA LAR-PDS® U.S. Patent Nos: D636,044 - D636,045 - D636,046 - D636,047 - D636,048 - D636,454 - D637,678 - D654,550 - D671,184

### RRA LAR-PDS® PISTOL - LP2110 - SPECIFICATIONS

CALIBER	5.56mm NATO Chamber for 5.56mm & .223 Cal.	PISTOL GRIP	Hogue Rubber Pistol Grip
UPPER RECEIVER	Proprietary, with Extended Top Rail	FRONT SLING / LIGHT MOUNT	MS1913 Rail on Regulator Housing
CHARGING HANDLE	Proprietary Ambidextrous Non-Reciprocating	REAR SLING MOUNT	MS1913 Rail on Rear Receiver Adapter
BARREL	9 Inch Chrome Moly, 1:9 Twist	LENGTH	18.25 Inches
MUZZLE DEVICE	A2 Flash Hider / 1/2-28 Thread	WEIGHT	5 Pounds
TRIGGER	RRA Two Stage	INCLUDES	One Magazine, Manual, Warranty

**Full Length Top Mounting Rail** The LAR-PDS® Pistol's full length top mounting rail, from the rear of the receiver to the regulator housing, allows for the flexible placement of numerous optics, lights, lasers and other accessories.







**Two Position Adjustable Regulator**

The LAR-PDS® Pistol's two position adjustable regulator is conveniently positioned on the right side of the regulator housing.



**Folding Ambidextrous Non-Reciprocating Charging Handles**

The folding ambidextrous, non-reciprocating charging handles, shown above in the extended position, may be used singly or in unison to charge the LAR-PDS® Pistol.



**Handguard with Operator Safety Flange**

With integral Operator Safety Flange to help prevent support-hand movement/slippage towards the muzzle.



**Rear Sling or Accessory Mounting Rail**

The LAR-PDS® Pistol features a MS1913 rail on the rear receiver adapter. The design of the upper receiver and guide rod base prevents gas blow-by to the back of the receiver.



**LAR-PDS® Aluminum Tri-Rail Handguard**

The LAR-PDS® Pistol is now available with the RRA Aluminum Tri-Rail Handguard for mounting lights, lasers and other accessories.



**MS1913 Rail on Regulator Housing**

The regulator housing features a MS1913 rail for attaching sling mounts or weapon lights.



**LAR-PDS® Aluminum Tri-Rail Handguard**

Pistol Length . . . . . LP0010P \$150

# LAR-PDS® - Piston Driven System

ROCK RIVER ARMS PISTON DRIVEN SYSTEM



## Rock River Arms LAR-PDS® Carbine Piston Driven System



The RRA LAR-PDS® Carbine is one of a new generation of firearms employing RRA's patent-pending *Piston Driven System (PDS)*. Featuring a purpose-designed bolt carrier, an adjustable gas piston and an over-the-barrel spring and guide rod arrangement, the LAR-PDS® is able to completely do away with the

traditional recoil system associated with AR-style firearms, making for an extremely versatile weapon platform. Several exciting new models are scheduled for release in 2013, as well as specialized parts and accessories.

**RRA LAR-PDS® Carbine** with LAR-PDS® Injection Molded Ribbed Handguard. . . . . LR1222 **\$1,595**

**RRA LAR-PDS® Carbine** with LAR-PDS® Aluminum Tri-Rail Handguard . . . . . LR1297 **\$1,750**

RRA LAR-PDS® U.S. Patent Nos: D636,044 - D636,045 - D636,046 - D636,047 - D636,048 - D636,454 - D637,678 - D654,550 - D671,184

### RRA LAR-PDS® CARBINE - LR1222 - SPECIFICATIONS

CALIBER	5.56mm NATO Chamber for 5.56mm & .223 Cal.	BUTTSTOCK	RRA Side-Folding 6-Position Tactical CAR Stock with Receiver Extension Storage Compartment
UPPER RECEIVER	Proprietary, with Extended Top Rail	LENGTH : WITH STOCK UNFOLDED/EXTENDED	37.75 Inches
CHARGING HANDLE	Proprietary Ambidextrous Non-Reciprocating	LENGTH : WITH STOCK UNFOLDED/RETRACTED	34.5 Inches
BARREL	16 Inch Chrome Moly, 1:9 Twist	LENGTH : WITH STOCK FOLDED	26 Inches
MUZZLE DEVICE	A2 Flash Hider, 1/2-28 Thread	WEIGHT	7.4 Pounds
TRIGGER	RRA Two Stage	INCLUDES	One Magazine, Manual, Warranty
PISTOL GRIP	Hogue Rubber Pistol Grip		

**Full Length Top Mounting Rail** The LAR-PDS® Carbine's full length top mounting rail, from the rear of the receiver to the regulator housing, allows for the flexible placement of numerous optics, lights, lasers and other accessories.

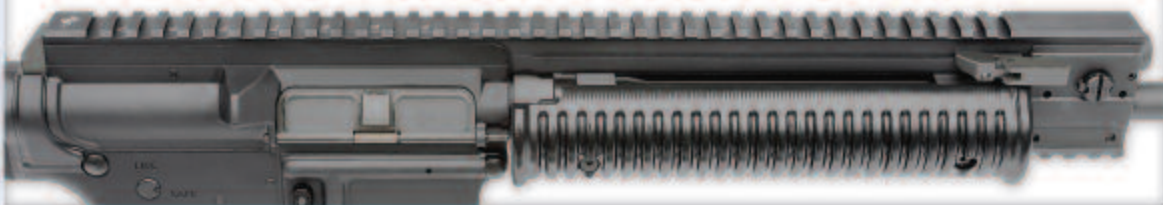





**Side-Folding Stock Adaptor**

The LAR-PDS® operating system allows for the elimination of the traditional "AR" receiver extension (containing the action spring and buffer) behind the lower receiver. The side-folding stock adaptor allows for the use of any "CAR style" stock, with adaptors for other types of stocks already planned.

**RRA LAR-PDS® Side-Folding Stock Kit**

Kit contains RRA Tactical CAR Stock, 6-Position PDS Receiver Extension with threaded end cap and internal storage, and Side Folding Hinge/Adapter unit. This kit is intended ONLY for use in converting legally registered LAR-PDS® pistols to stocked SBRs, and a copy of the Form 1 registration is required to complete the purchase. NOTE: This kit is not compatible with other bufferless platforms due to the means of attachment to the proprietary LAR-PDS® lower receiver.

LR0255 ..... \$175

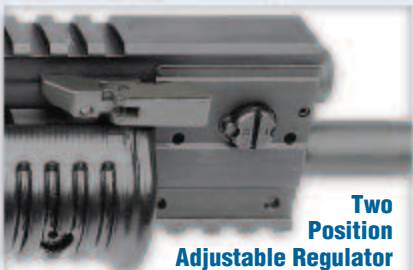

**Two Position Adjustable Regulator**

The LAR-PDS® Carbine's two position adjustable regulator is conveniently positioned on the right side of the regulator housing.



**MS1913 Rail on Regulator Housing**

The LAR-PDS® Carbine's regulator housing features a MS1913 rail for attaching sling mounts, weapon lights or other accessories.



**Folding Ambidextrous Non-Reciprocating Charging Handles**

The folding ambidextrous, non-reciprocating charging handles, shown above in the extended position, may be used singly or in unison to charge the RRA LAR-PDS® Carbine.



**RRA LAR-PDS® Injection Molded Ribbed Handguard**

The LAR-PDS® Carbine is available with the unique RRA Injection Molded Ribbed Handguard, for a comfortable and sure grip.



**RRA LAR-PDS® Aluminum Tri-Rail Handguard**

The LAR-PDS® Carbine is now available with the RRA Aluminum Tri-Rail Handguard for mounting lights, lasers, foregrips, etc.

**LAR-PDS® Aluminum Tri-Rail Handguard**

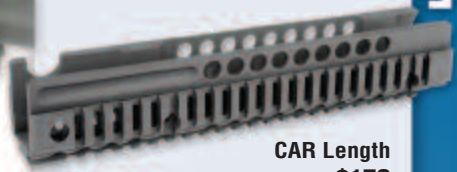

CAR Length  
LR0010H . . . \$170



RRA LAR-8® 7.62MM / 308



**RRA  
Tactical  
CAR Stock**

**Hogue  
Grip**

**RRA  
Two Stage  
Trigger**

**Cryogenically  
Treated Barrel**

**RRA LAR-8®**  
**Mid-Length A4**



**RRA LAR-8®**  
U.S. Patent No.  
7,219,462

**Uses RRA LAR-8® mags,  
FAL / Metric mags and  
L1A1 / Inch mags.**

*Shown with  
optional RRA  
Operator CAR Stock*

**RRA LAR-8® Mid-Length A4**

**Standard Configuration . . . . . 308A1239 \$1,335**

**POPULAR OPTIONS AND UPGRADES**

Substitute RRA Aluminum Free Float Tube	<b>Add \$100</b>
Substitute RRA Quad Rail Free Float with 3 Rail Covers	<b>Add \$165</b>
Substitute RRA Advanced Half Quad with 3 Rail Covers	<b>Add \$200</b>
Substitute RRA Flip Front Sight Gas Block	<b>Add \$90</b>
Substitute Smith Vortex Flash Hider	<b>Add \$88</b>
Substitute PRi Gas Buster Charging Handle	<b>Add \$65</b>
Substitute RRA Operator CAR Stock	<b>Add \$50</b>
Substitute ACE ARFX Skeleton Stock	<b>Add \$42.50</b>
Substitute Ambidextrous Safety Selector	<b>Add \$25</b>
Substitute RRA Winter Trigger Guard	<b>Add \$10</b>

**COMPLETE OPTIONS & UPGRADES LISTING ON PAGES 4 & 5**

**STANDARD CONFIGURATION**

CALIBER	.308/7.62x51mm NATO Chamber
LOWER RECEIVER	Forged RRA LAR-8®
UPPER RECEIVER	Forged A4 with Forward Assist and Port Door
BARREL	16 Inch Chrome Moly, 1:10 Twist, Cryogenically Treated
MUZZLE DEVICE	A2 Flash Hider / 5/8-24 Thread
FRONT SIGHT BASE	Gas Block Sight Base
TRIGGER	RRA Two Stage
PISTOL GRIP	Hogue Rubber Pistol Grip
BUTTSTOCK	RRA 6-Position Tactical CAR Stock
HANDGUARD	Mid-Length Handguard
WEIGHT	8.1 Pounds
LENGTH	38 Inches
ACCURACY	1.5 MOA at 100 Yards
INCLUDED	One Mag, RRA Case, Manual, Warranty

**.308 Caliber Mid-Length A4 Complete Upper Halves**

**Includes Bolt Carrier Group and  
Charging Handle Assembly**

**STANDARD CONFIGURATION**

CALIBER	.308/7.62x51mm NATO Chamber
UPPER RECEIVER	Forged A4 with Forward Assist and Port Door
BARREL	16 Inch Chrome Moly, 1:10 Twist, Cryogenically Treated
MUZZLE DEVICE	A2 Flash Hider / 5/8-24 Thread
FRONT SIGHT BASE	Gas Block Sight Base
HANDGUARD	Mid-Length Handguard



**.308 Caliber Mid-Length A4 Complete Upper Half**

**Standard Configuration . . . . . 308A0375 \$825**



**Cryogenically Treated Barrel**

**Hogue Grip**

**RRA Two Stage Trigger**

# RRA LAR-8<sup>®</sup> Standard A4

RRA LAR-8<sup>®</sup>  
U.S. Patent No.  
7,219,462



*Shown with optional RRA Operator A2 Stock, RRA Aluminum Free Float Tube, and RRA Winter Trigger Guard*

**Uses RRA LAR-8<sup>®</sup> mags, FAL / Metric mags and L1A1 / Inch mags.**

## STANDARD CONFIGURATION

CALIBER	.308/7.62x51mm NATO Chamber
LOWER RECEIVER	Forged RRA LAR-8 <sup>®</sup>
UPPER RECEIVER	Forged A4 with Forward Assist and Port Door
BARREL	20 Inch Chrome Moly, 1:10 Twist, Cryogenically Treated
MUZZLE DEVICE	A2 Flash Hider / 5/8-24 Thread
FRONT SIGHT BASE	Gas Block Sight Base
TRIGGER	RRA Two Stage
PISTOL GRIP	Hogue Rubber Pistol Grip
BUTTSTOCK	A2 Buttstock
HANDGUARD	A2 Handguard
WEIGHT	9.0 Pounds
LENGTH	42 Inches
ACCURACY	1 MOA at 100 Yards
INCLUDED	One Mag, RRA Case, Manual, Warranty

## RRA LAR-8<sup>®</sup> Standard A4

Standard Configuration . . . . . 308A1288 **\$1,370**

## POPULAR OPTIONS AND UPGRADES

Substitute RRA Aluminum Free Float Tube	<b>Add \$105</b>
Substitute RRA Quad Rail Free Float with 3 Rail Covers	<b>Add \$190</b>
Substitute RRA Advanced Half Quad with 3 Rail Covers	<b>Add \$215</b>
Substitute RRA Flip Front Sight Gas Block	<b>Add \$90</b>
Substitute Smith Vortex Flash Hider	<b>Add \$88</b>
Substitute PRI Gas Buster Charging Handle	<b>Add \$65</b>
Substitute RRA Operator A2 Stock	<b>Add \$50</b>
Substitute ACE ARFX Skeleton Stock	<b>Add \$52.50</b>
Substitute Ambidextrous Safety Selector	<b>Add \$25</b>
Substitute RRA Winter Trigger Guard	<b>Add \$10</b>

**COMPLETE OPTIONS & UPGRADES LISTING ON PAGES 4 & 5**

## .308 Caliber Standard A4 Complete Upper Halves

**Includes Bolt Carrier Group and Charging Handle Assembly**



## .308 Caliber Standard A4 Complete Upper Half

Standard Configuration . . . . . 308A0450 **\$855**

## STANDARD CONFIGURATION

CALIBER	.308/7.62x51mm NATO Chamber
UPPER RECEIVER	Forged A4 with Forward Assist and Port Door
BARREL	20 Inch Chrome Moly, 1:10 Twist, Cryogenically Treated
MUZZLE DEVICE	A2 Flash Hider / 5/8-24 Thread
FRONT SIGHT BASE	Gas Block Sight Base
HANDGUARD	A2 Handguard

RRA LAR-8<sup>®</sup> 7.62MM / .308

RRA LAR-8® 7.62MM / .308



Hogue Grip

RRA Two Stage Trigger

RRA Flip Front Sight Gas Block

# RRA LAR-8® Elite Operator



Shown with optional RRA LAR-8® Tactical Mount

Cryogenically Treated Barrel

RRA LAR-8® Advanced Half Quad with 3 Ladder Rail Covers

Advanced Half Quad Handguard style may vary from picture

RRA Operator CAR Stock

RRA LAR-8®  
U.S. Patent No.  
7,219,462

Uses RRA LAR-8® mags,  
FAL / Metric mags and  
L1A1 / Inch mags.

## RRA LAR-8® Elite Operator

Standard Configuration . . . . . 308A1276 **\$1,740**

### POPULAR OPTIONS AND UPGRADES

Substitute PRI Gas Buster Charging Handle	<b>Add \$65</b>
Substitute Ambidextrous Safety Selector	<b>Add \$25</b>
Substitute ERGO SureGrip Pistol Grip	<b>No Charge</b>
Substitute ERGO Tactical Deluxe Pistol Grip	<b>Add \$45</b>
Substitute RRA Winter Trigger Guard	<b>Add \$10</b>

COMPLETE OPTIONS & UPGRADES LISTING ON PAGES 4 & 5

### STANDARD CONFIGURATION

CALIBER	.308/7.62x51mm NATO Chamber
LOWER RECEIVER	Forged RRA LAR-8®
UPPER RECEIVER	Forged A4 with Forward Assist and Port Door
BARREL	16 Inch Chrome Moly, 1:10 Twist, Cryogenically Treated
MUZZLE DEVICE	Smith Vortex Flash Hider / 5/8-24 Thread
GAS BLOCK	RRA Flip Front Sight Gas Block
TRIGGER	RRA Two Stage
PISTOL GRIP	Hogue Rubber Pistol Grip
BUTTSTOCK	RRA Operator CAR Stock
HANDGUARD	RRA Advanced Half Quad Free Float with 3 Ladder Rail Covers
WEIGHT / LENGTH	9.1 Pounds / 38 Inches
ACCURACY	1.5 MOA at 100 Yards
INCLUDED	One Mag, RRA Case, Manual, Warranty

## .308 Caliber Elite Operator Complete Upper Half

Includes Bolt Carrier Group and Charging Handle Assembly

### STANDARD CONFIGURATION

CALIBER	.308/7.62x51mm NATO Chamber
UPPER RECEIVER	Forged A4 with Forward Assist and Port Door
BARREL	16 Inch Chrome Moly, 1:10 Twist, Cryogenically Treated
MUZZLE DEVICE	Smith Vortex Flash Hider / 5/8-24 Thread
GAS BLOCK	RRA Flip Front Sight Gas Block
HANDGUARD	RRA Advanced Half Quad with 3 Rail Covers

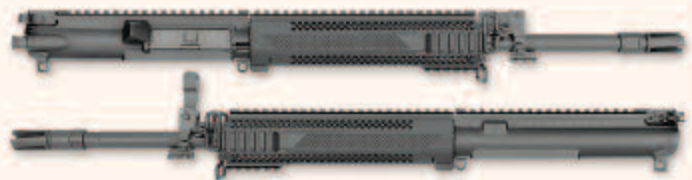

## .308 Caliber Elite Operator Complete Upper Half

Standard Configuration . . . . . 308A0432 **\$1,180**



**RRA Flip Front Sight Gas Block**

*Shown with optional RRA LAR-8® Stand Alone Rear Sight*

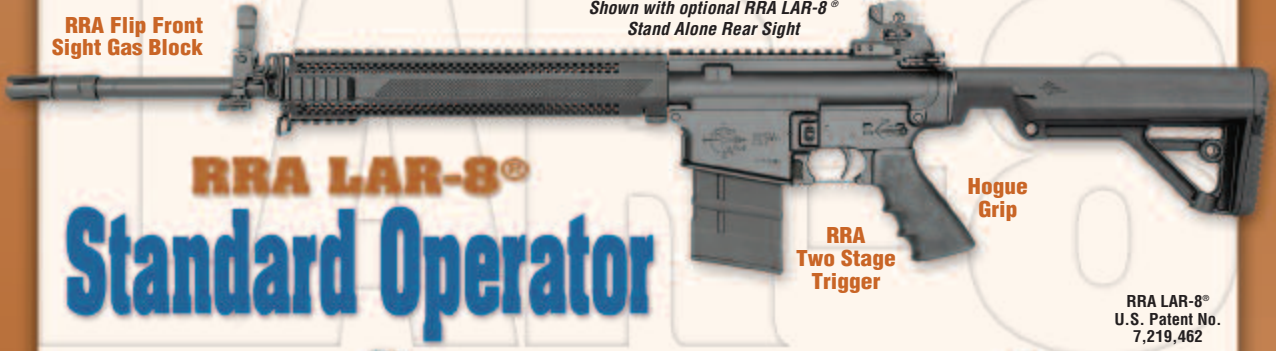

# RRA LAR-8® Standard Operator

**Hogue Grip**

**RRA Two Stage Trigger**

RRA LAR-8®  
U.S. Patent No. 7,219,462

*Shown with optional RRA LAR-8® Dominator2 EOTech Mount*



**RRA Operator A2 Stock**

**RRA LAR-8 Advanced Half Quad with 3 Ladder Rail Covers**

Advanced Half Quad Handguard style may vary from picture

**Cryogenically Treated Barrel**

**Add the RRA LAR-8® Dominator2 EOTech Mount Assembly**

With A2 Rear Sight

308A0125FASSY \$175



**Add the RRA LAR-8® Stand Alone Rear Sight**

With A2 Rear Sight

308A3305ASY \$110



## STANDARD CONFIGURATION

CALIBER	.308/7.62x51mm NATO Chamber
LOWER RECEIVER	Forged RRA LAR-8®
UPPER RECEIVER	Forged A4 with Forward Assist and Port Door
BARREL	20 Inch Chrome Moly, 1:10 Twist, Cryogenically Treated
MUZZLE DEVICE	Smith Vortex Flash Hider / 5/8-24 Thread
GAS BLOCK	RRA Flip Front Sight Gas Block
TRIGGER	RRA Two Stage
PISTOL GRIP	Hogue Rubber Pistol Grip
BUTTSTOCK	RRA Operator A2 Stock
HANDGUARD	RRA Advanced Half Quad Free Float with 3 Ladder Rail Covers
WEIGHT / LENGTH	10.2 Pounds / 42 Inches
ACCURACY	1 MOA at 100 Yards
INCLUDED	One Mag, RRA Case, Manual, Warranty

Uses RRA LAR-8® mags, FAL / Metric mags and L1A1 / Inch mags.

## RRA LAR-8® Standard Operator

Standard Configuration . . . . . 308A1279 \$1,790

### POPULAR OPTIONS AND UPGRADES

Substitute PRI Gas Buster Charging Handle	<b>Add \$65</b>
Substitute Ambidextrous Safety Selector	<b>Add \$25</b>
Substitute ERGO SureGrip Pistol Grip	<b>No Charge</b>
Substitute ERGO Tactical Deluxe Pistol Grip	<b>Add \$45</b>
Substitute RRA Winter Trigger Guard	<b>Add \$10</b>

**COMPLETE OPTIONS & UPGRADES LISTING ON PAGES 4 & 5**

## .308 Caliber Standard Operator Complete Upper Half

**Includes Bolt Carrier Group and Charging Handle Assembly**

### STANDARD CONFIGURATION

CALIBER	.308/7.62x51mm NATO Chamber
UPPER RECEIVER	Forged A4 with Forward Assist and Port Door
BARREL	20 Inch Chrome Moly, 1:10 Twist, Cryogenically Treated
MUZZLE DEVICE	Smith Vortex Flash Hider / 5/8-24 Thread
GAS BLOCK	RRA Flip Front Sight Gas Block
HANDGUARD	RRA Advanced Half Quad with 3 Rail Covers

## .308 Caliber Standard Operator Complete Upper Half

Standard Configuration . . . . . 308A0433 \$1,225



RRA LAR-8® 7.62MM / .308

RRA LAR-8® 7.62MM / .308



Hogue Grip

**Predator HP™ 308A1530**  
With A2 Buttstock

**Cryogenically Treated Bead Blasted Stainless Steel Heavy Barrel**

**RRA Two Stage Trigger and RRA Winter Trigger Guard**

**RRA LAR-8®**

# Predator HP™

**Uses RRA LAR-8® mags, FAL / Metric mags and L1A1 / Inch mags.**



RRA LAR-8®  
U.S. Patent No.  
7,219,462

**RRA Aluminum Free Float Tube**

**Predator HP™ 308A1532**  
With RRA Operator A2 Stock

## RRA LAR-8® Predator HP™

- With A2 Buttstock** ..... 308A1530 **\$1,605**
- With RRA Operator A2 Stock** ..... 308A1532 **\$1,655**

### POPULAR OPTIONS AND UPGRADES

- Substitute RRA Quad Rail Free Float with 3 Rail Covers **Add \$110**
- Substitute RRA Advanced Half Quad with 3 Rail Covers **Add \$145**
- Substitute RRA LAR-8 Flip Front Sight Gas Block **Add \$90**
- Substitute Pri Gas Buster Charging Handle **Add \$65**
- Substitute ERGO SureGrip Pistol Grip **No Charge**
- Substitute ERGO Tactical Deluxe Pistol Grip **Add \$45**
- Substitute Ambidextrous Safety Selector **Add \$25**

**COMPLETE OPTIONS & UPGRADES LISTING ON PAGES 4 & 5**

### STANDARD CONFIGURATION

CALIBER	.308/7.62x51mm NATO Chamber
LOWER RECEIVER	Forged RRA LAR-8®
UPPER RECEIVER	Forged A4 with Forward Assist and Port Door
BARREL	20 Inch Bead Blasted Stainless Steel HBAR, 1:10 Twist, Cryo Treated
GAS BLOCK	Gas Block Sight Base
TRIGGER	RRA Two Stage
TRIGGER GUARD	RRA Winter Trigger Guard
PISTOL GRIP	Hogue Rubber Pistol Grip
HANDGUARD	RRA Aluminum Free Float Tube
WEIGHT	8.6 Pounds
LENGTH	40 Inches
ACCURACY	1 MOA at 100 Yards
INCLUDED	One Mag, RRA Case, Manual, Warranty

## .308 Caliber Predator HP™ Complete Upper Half

**Includes Bolt Carrier Group and Charging Handle Assembly**



### STANDARD CONFIGURATION

CALIBER	.308/7.62x51mm NATO Chamber
UPPER RECEIVER	Forged A4 with Forward Assist and Port Door
BARREL	20" Bead Blasted Stainless HBAR, 1:10 Twist, Cryo Treated
GAS BLOCK	Gas Block Sight Base
HANDGUARD	RRA Aluminum Free Float Tube



## .308 Caliber Predator HP™ Complete Upper Half

**Standard Configuration** ..... 308A0565 **\$975**



**Cryogenically Treated  
Air Gauged Stainless Steel  
Bull Barrel**

**RRA Aluminum Free Float Tube**

**RRA Two Stage Trigger and  
RRA Winter Trigger Guard**

**Hogue  
Grip**

**RRA LAR-8®**

# Varmint A4

**Uses RRA LAR-8® mags,  
FAL / Metric mags and  
L1A1 / Inch mags.**



*Shown with optional  
RRA LAR-8® Advanced Half Quad Free Float  
and RRA Operator A2 Stock*

**RRA LAR-8®  
U.S. Patent No.  
7,219,462**

## STANDARD CONFIGURATION

CALIBER	.308/7.62x51mm NATO Chamber	
LOWER RECEIVER	Forged RRA LAR-8®	
UPPER RECEIVER	Forged A4 with Forward Assist and Port Door	
BARREL	20 or 26 Inch Bull Stainless Steel, 1:10 Twist, Cryogenically Treated	
GAS BLOCK	Varmint Gas Block with Sight Rail	
TRIGGER	RRA Two Stage	
TRIGGER GUARD	RRA Winter Trigger Guard	
PISTOL GRIP	Hogue Rubber Pistol Grip	
BUTTSTOCK	A2 Buttstock	
HANDGUARD	RRA Aluminum Free Float Tube	
WEIGHT / LENGTH	26 INCH	11.6 Pounds / 46 Inches
	20 INCH	10.4 Pounds / 40 Inches
ACCURACY	1 MOA at 100 Yards	
INCLUDED	One Mag, RRA Case, Manual, Warranty	

## RRA LAR-8® Varmint A4

**Varmint A4 - 26 Inch Barrel . . . . . 308A1560 \$1,575**  
**Varmint A4 - 20 Inch Barrel . . . . . 308A1520 \$1,570**

## POPULAR OPTIONS AND UPGRADES

Substitute RRA Quad Rail Free Float with 3 Rail Covers	<b>Add \$110</b>
Substitute RRA Advanced Half Quad with 3 Rail Covers	<b>Add \$145</b>
Substitute PRi Gas Buster Charging Handle	<b>Add \$65</b>
Substitute RRA Operator A2 Stock	<b>Add \$50</b>
Substitute ACE ARFX Skeleton Stock	<b>Add \$52.50</b>
Substitute ERGO SureGrip Pistol Grip	<b>No Charge</b>
Substitute ERGO Tactical Deluxe Pistol Grip	<b>Add \$45</b>
Substitute Ambidextrous Safety Selector	<b>Add \$25</b>

**COMPLETE OPTIONS & UPGRADES LISTING ON PAGES 4 & 5**

## .308 Caliber Varmint A4 Complete Upper Halves

**Includes Bolt Carrier Group  
and Charging Handle Assembly**



## .308 Caliber Varmint A4 Complete Upper Halves

**Varmint A4 - 26 Inch Barrel . . . . . 308A0582 \$960**  
**Varmint A4 - 20 Inch Barrel . . . . . 308A0550 \$950**

## STANDARD CONFIGURATION

CALIBER	.308/7.62x51mm NATO Chamber	
UPPER RECEIVER	Forged A4 with Forward Assist and Port Door	
BARREL	20" or 26" Bull Stainless Steel, 1:10, Cryogenically Treated	
GAS BLOCK	Varmint Gas Block with Sight Rail	
HANDGUARD	RRA Aluminum Free Float Tube	

**RRA LAR-8® 7.62MM / .308**



# RRA LAR-8® Upper Half Parts

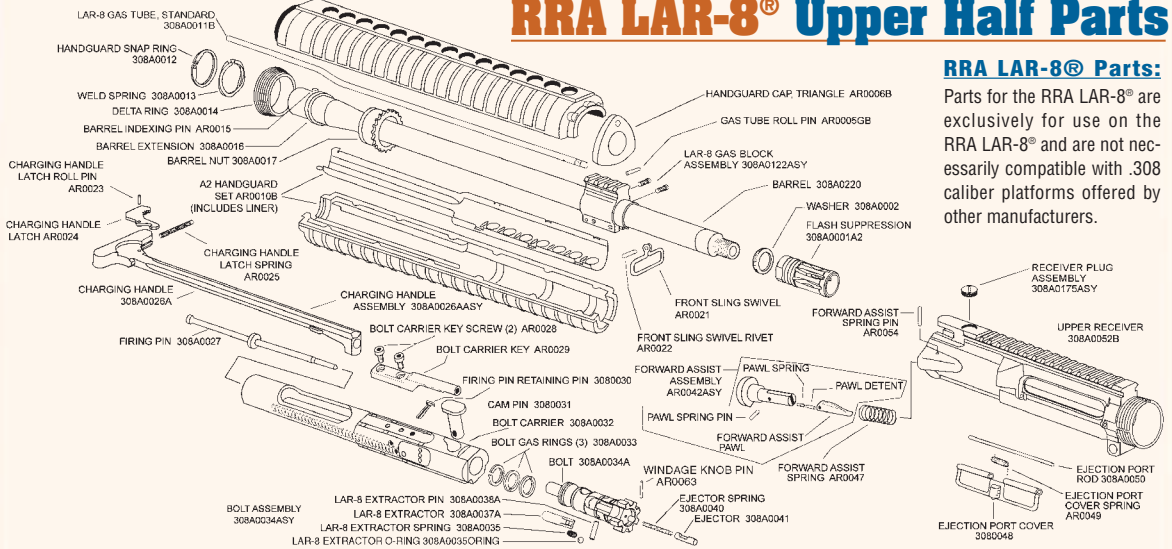

## RRA LAR-8® Parts:

Parts for the RRA LAR-8® are exclusively for use on the RRA LAR-8® and are not necessarily compatible with .308 caliber platforms offered by other manufacturers.

<b>LAR-8 flash suppressor</b>	<b>308A0001A2</b>	<b>\$37.50</b>
<b>LAR-8 crush washer</b>	<b>308A0002</b>	<b>\$3.75</b>
Gas tube roll pin	AR0005GB	\$.50
Handguard cap, triangle	AR0006B	\$2.00
<b>LAR-8 Gas Block Sight Base</b>	<b>308A0122ASY</b>	<b>\$46.00</b>
<b>LAR-8 Low Profile Gas Block</b>	<b>308A0122LPASY</b>	<b>\$50.00</b>
<b>LAR-8 Varmint Gas Block Sight Base</b>	<b>308A0122VASY</b>	<b>\$45.00</b>
A2 Handguard Set, includes liner	AR0010B	\$19.00
<b>LAR-8 gas tube, standard</b>	<b>308A0011B</b>	<b>\$12.00</b>
<b>LAR-8 gas tube, mid-length</b>	<b>308A0011C</b>	<b>\$12.00</b>
<b>LAR-8 handguard snap ring</b>	<b>308A0012</b>	<b>\$1.25</b>
<b>LAR-8 weld spring</b>	<b>308A0013</b>	<b>\$7.00</b>
<b>LAR-8 delta ring</b>	<b>308A0014</b>	<b>\$8.50</b>
Barrel indexing pin	AR0015	\$2.00
<b>LAR-8 barrel extension</b>	<b>308A0016</b>	<b>\$41.50</b>
<b>LAR-8 barrel nut</b>	<b>308A0017</b>	<b>\$13.00</b>
Front sling swivel	AR0021	\$3.50
Front sling swivel rivet	AR0022	\$1.00
Charging handle latch roll pin	AR0023	\$.50
Charging handle latch	AR0024	\$2.50
Charging handle latch spring	AR0025	\$.50
<b>LAR-8 charging handle</b>	<b>308A0026A</b>	<b>\$40.00</b>
<b>LAR-8 Charging Handle Assembly</b>	<b>308A0026AASY</b>	<b>\$42.00</b>

<b>LAR-8 firing pin</b>	<b>308A0027</b>	<b>\$10.50</b>
Bolt carrier key screw, each (2 required)	AR0028	\$1.00
Bolt carrier key	AR0029	\$11.50
<b>LAR-8 firing pin retaining pin</b>	<b>3080030</b>	<b>\$1.25</b>
<b>LAR-8 cam pin</b>	<b>3080031</b>	<b>\$7.50</b>
<b>LAR-8 bolt carrier, stripped</b>	<b>308A0032</b>	<b>\$90.00</b>
<b>LAR-8 bolt gas rings, each (3 required)</b>	<b>308A0033</b>	<b>\$1.50</b>
<b>LAR-8 bolt</b>	<b>308A0034A</b>	<b>\$89.00</b>
<b>LAR-8 Bolt Assembly</b>	<b>308A0034ASY</b>	<b>\$140.00</b>
<b>LAR-8 extractor spring</b>	<b>308A0035</b>	<b>\$.75</b>
<b>LAR-8 extractor o-ring</b>	<b>308A0035ORING</b>	<b>\$1.00</b>
<b>LAR-8 extractor</b>	<b>308A0037A</b>	<b>\$23.00</b>
<b>LAR-8 extractor pin</b>	<b>308A0038A</b>	<b>\$2.75</b>
<b>LAR-8 ejector spring</b>	<b>308A0040</b>	<b>\$.75</b>
<b>LAR-8 ejector</b>	<b>308A0041</b>	<b>\$2.75</b>
<b>Forward Assist Assembly</b>	AR0042ASY	\$12.00
Forward assist spring	AR0047	\$1.00
<b>LAR-8 Ejection Port Cover</b>	<b>3080048</b>	<b>\$8.50</b>
Ejection port cover spring	AR0049	\$.50
<b>LAR-8 ejection port door rod</b>	<b>308A0050</b>	<b>\$1.50</b>
Forward assist spring pin	AR0054	\$.50
Windage knob pin	AR0063	\$.50
<b>LAR-8 A4 receiver plug assembly</b>	<b>308A0175ASY</b>	<b>\$7.50</b>



## RRA LAR-8® Front Sight Housing with Rail

308A0004  
\$50

## RRA LAR-8® Flip Front Sight Gas Block Assembly

With three sling swivels and tactical rail in bayonet lug position.

308A3330ASY . . . \$100



## Pri Gas Buster Charging Handle

For the RRA LAR-8®



With the Military "Big Latch", designed to deflect gasses away from the shooter's face.

308A0026GBASY . . . . . \$90

# RRA LAR-8® Lower Half Parts

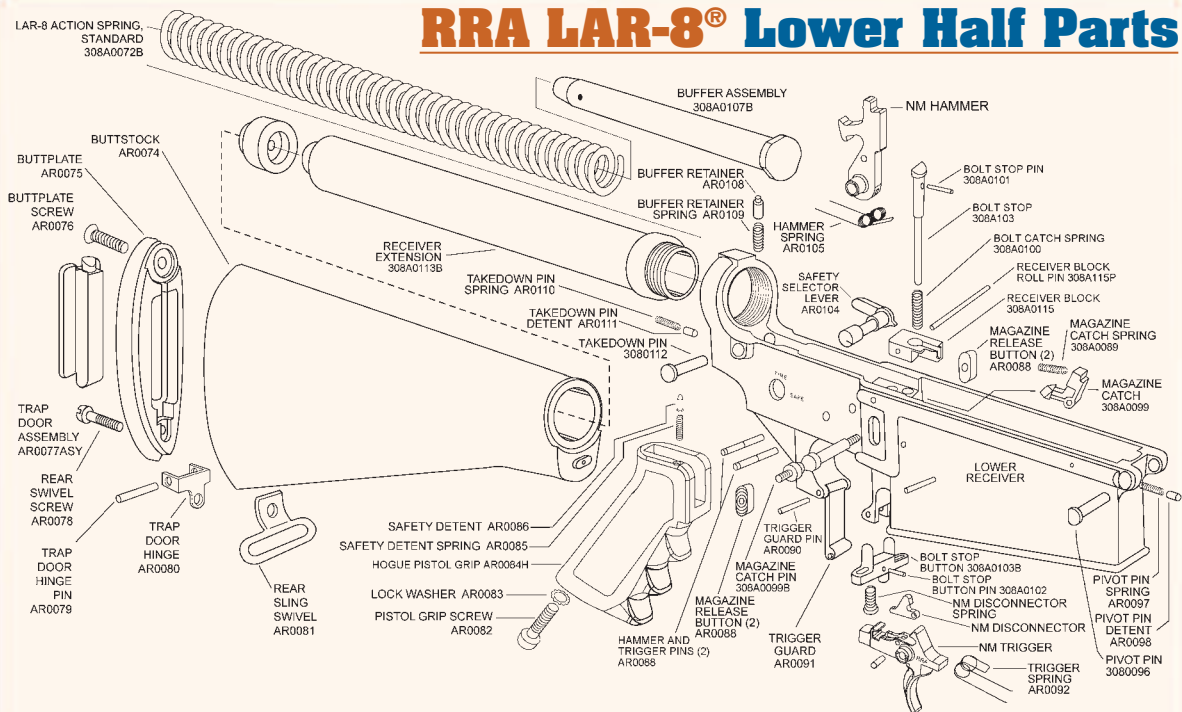

<b>LAR-8 action spring, standard</b>	<b>308A0072B</b>	\$5.00	Pivot pin spring	AR0097	\$5.00
<b>LAR-8 action spring, 14.5 inch</b>	<b>308A0072C</b>	\$5.00	Pivot pin detent	AR0098	\$5.00
Buttplate	AR0075	\$3.00	<b>LAR-8 magazine catch</b>	<b>308A0099</b>	\$7.75
Buttplate screw	AR0076	\$3.00	<b>LAR-8 magazine catch pin</b>	<b>308A0099B</b>	\$4.25
Trap Door Assembly, plastic	AR0077PASY	\$5.00	<b>LAR-8 bolt catch spring</b>	<b>308A0100</b>	\$7.75
Rear swivel screw	AR0078	\$1.00	<b>LAR-8 bolt stop pin</b>	<b>308A0101</b>	\$5.00
Trap door hinge pin	AR0079	\$7.75	<b>LAR-8 bolt stop button pin</b>	<b>308A0102</b>	\$5.00
Trap door hinge	AR0080	\$3.00	<b>LAR-8 bolt stop</b>	<b>308A0103</b>	\$8.00
Rear sling swivel	AR0081	\$2.75	<b>LAR-8 bolt stop button</b>	<b>308A0103B</b>	\$10.00
Pistol grip screw	AR0082	\$1.00	Safety selector lever, standard	AR0104	\$9.00
Lock washer	AR0083	\$5.00	Hammer spring	AR0105	\$1.00
Hogue pistol grip	AR0084H	\$22.00	<b>LAR-8 buffer assembly, CAR</b>	<b>308A0107A</b>	\$14.50
Safety detent spring	AR0085	\$5.00	<b>LAR-8 buffer assembly, Standard</b>	<b>308A0107B</b>	\$15.50
Safety detent	AR0086	\$7.75	Buffer retainer	AR0108	\$7.70
Hammer and trigger pin, NM (2 required)	AR0087NM	\$2.00	Buffer retainer spring	AR0109	\$5.00
Magazine release button (2 required)	AR0088	\$2.00	Takedown pin spring	AR0110	\$5.00
<b>LAR-8 magazine catch spring</b>	<b>308A0089</b>	\$7.75	Takedown pin detent	AR0111	\$5.00
Trigger guard pivot roll pin	AR0090	\$5.00	<b>LAR-8 takedown pin</b>	<b>3080112</b>	\$7.50
Trigger guard	AR0091	\$5.00	<b>LAR-8 receiver extension tube, CAR 6-pos.</b>	<b>308A0113A</b>	\$20.00
Trigger spring	AR0092	\$1.00	<b>LAR-8 receiver extension tube, Standard</b>	<b>308A0113B</b>	\$32.00
<b>Two Stage Match Trigger Kit</b>	AR0093NMK	\$120.00	<b>LAR-8 receiver block</b>	<b>308A0115</b>	\$9.00
<b>LAR-8 pivot pin</b>	<b>3080096</b>	\$7.50	<b>LAR-8 receiver block roll pin</b>	<b>308A0115P</b>	\$7.75

**RRA LAR-8® Parts and Accessories Compatibility:** Unlike AR-15 type rifles which share a common platform and general commonality of component parts, pieces and accessories, .308 caliber AR platforms are all uniquely designed by their manufacturers and do not share common component parts, pieces, and accessories. While some components MAY interchange between models/platforms made by different manufacturers, this commonality is by chance, not by design. Parts, pieces, and accessories manufactured by RRA and its vendors for the RRA LAR-8® platform are only to be used on the RRA LAR-8® and NOT on any other model/platform made by any other manufacturer, no matter how similar the rifles may be in appearance. Additionally, component parts, pieces, and accessories manufactured specifically for any other model/platform should never be used on the RRA LAR-8®. To do so risks damage to the rifle and injury or death to the shooter/bystanders. Any questions concerning the suitability of parts, pieces and accessories for the RRA LAR-8® should be directed to the RRA Sales/Customer Service Department at 866-980-7625 or info@rockriverarms.com.

RRA LAR-8® 7.62MM / .308



## RRA LAR-8® Complete Lower Halves

- With A2 Buttstock, Hogue Pistol Grip**
- Standard Trigger..... 308A0900 **\$440**
  - RRA Two Stage Trigger..... 308A0940 **\$540**
- With RRA Tactical CAR Stock, Hogue Pistol Grip**
- Standard Trigger..... 308A0901 **\$455**
  - RRA Two Stage Trigger..... 308A0990 **\$555**



## RRA LAR-8® A4 Upper Receiver Assembly

- Complete with forward assist and port door.
- Complete..... 308A0052BASY **\$195**
  - Stripped A4 Upper Receiver..... 308A0052B **\$160**

### RRA LAR-8® Complete Bolt Carrier Group



Semi-auto..... 308A0032AGRP **\$220**

### RRA LAR-8® Forged Ambi Charging Handle Assembly



308A0026ASYAMBI **\$65**

## RRA LAR-8® Spare Parts Kits

- RRA LAR-8® Pin Kit** All of the pins that you are likely to need to maintain your RRA LAR-8..... 308A3252 **\$10.50**
- RRA LAR-8® "Oh Shoot" Kit** All of the parts and pieces for your RRA LAR-8 that you are most likely to wear out or lose at the worst possible time..... 308A3256 **\$15**
- RRA LAR-8® Spring Kit** All of the springs that you are likely to need to maintain your RRA LAR-8.
- For LAR-8 with CAR stock..... 308A3255A **\$22**
- For LAR-8 with A2/Rifle stock..... 308A3255B **\$22**
- RRA LAR-8® Bolt Rebuild Kit** All of the parts necessary to rebuild the LAR-8 bolt assembly..... 308A3258 **\$40**

## RRA LAR-8® Barrel Assemblies

All Cryogenically Treated



### RRA LAR-8® Chrome Moly Heavy

- .308/7.62x51mm NATO chamber, 1:10 twist, 5/8-24 threaded muzzle, with barrel nut, handguard cap and front sight housing with rail.
- 16 Inch Mid-Length**..... 308A0210ASY **\$250**
  - Chrome Lined Bore/Chamber**..... 308A0212ASY **\$305**
  - 20 Inch Standard**..... 308A0220ASY **\$275**



### RRA LAR-8® Chrome Moly Varmint

- .308/7.62x51mm NATO chamber, 1:10 twist, with Varmint Gas Block.
- 20 Inch Varmint**..... 308A0236ASY **\$290**
  - With 5/8-24 Threaded Muzzle**..... 308A0234ASY **\$310**



### RRA LAR-8® Stainless Steel Heavy

- .308/7.62x51mm NATO chamber, 1:10 twist, with Gas Block Sight Base.
- 20 Inch Heavy**..... 308A0223ASY **\$325**

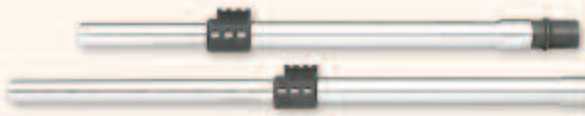

### RRA LAR-8® Stainless Steel Varmint

- .308/7.62x51mm NATO chamber, 1:10 twist, with Varmint Gas Block.
- 20 Inch Varmint**..... 308A0226ASY **\$380**
  - 26 Inch Varmint**..... 308A0227ASY **\$395**

## Smith Vortex Flash Hider

.308 Caliber 5/8-24 Thread  
308A0001V... **\$90**

## Smith Muzzle Brake

.308 Caliber 5/8-24 Thread, ATF approved for AWB compliance if pinned and welded.  
308A0117V... **\$90**





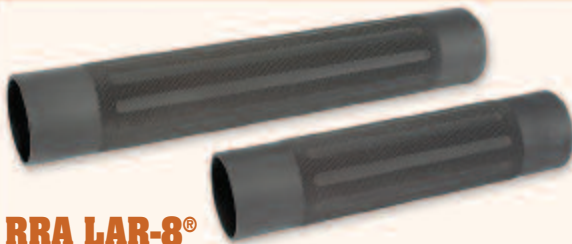

## RRA LAR-8® Aluminum Free Float Tubes

Mid-Length ..... 308A0010CAH \$100  
 Rifle Length ..... 308A0010BAH \$105



## RRA LAR-8® Quad Rail Aluminum Free Float

Each includes three Ladder Rail Covers, seven slot.  
 Mid-Length ..... 308A0010H \$160  
 Rifle Length ..... 308A0010G \$185



## RRA LAR-8® Advanced Half Quad Aluminum Free Float

Each includes three Ladder Rail Covers, seven slot.  
 Mid-Length ..... 308A0010HA \$195  
 Rifle Length ..... 308A0010GA \$205

Advanced Half Quad Handguard style may vary from picture

### The RRA LAR-8® uses a unique receiver thread length and barrel nut.

No barrel nut (either separate or as part of a tubular handguard or quad rail handguard) except those made specifically for the RRA LAR-8® should ever be used on an RRA LAR-8® rifle or upper half. While some other barrel nuts may thread onto the upper receiver, the depth of thread is incorrect and use of such a barrel nut not specifically made for use with the LAR-8® (and identified as such by RRA) may expose the shooter to risk of injury or death.



## RRA LAR-8® A2 Buttstock Kit

Includes buttstock with buttplate, sling loop, buffer, buffer tube, buffer spring, spacer and screw.

LAR-8 A2 Buttstock Kit ..... 308A0074K \$85



## RRA LAR-8® Operator A2 Stock Kit

Includes stock with integral ribbed rubber buttplate, receiver extension, buffer, and buffer spring.

LAR-8 Operator A2 Stock Kit ..... 308A0074NK \$145



## RRA LAR-8® Tactical CAR Stock Kit

6-position collapsible, complete with swivel, receiver extension, end plate, lock nut, CAR buffer and spring.

LAR-8 Tactical CAR Stock Kit ..... 308A0250 \$80



## RRA LAR-8® Operator CAR Stock Kit

6-position collapsible, with rubber buttplate, receiver extension, end plate, lock nut, CAR buffer and spring.

LAR-8 Operator CAR Stock Kit ..... 308A0250N \$145

### RRA LAR-8® Parts and Accessories Compatibility:

Unlike AR-15 type rifles which share a common platform and general commonality of component parts, pieces and accessories, .308 caliber AR platforms are all uniquely designed by their manufacturers and do not share common component parts, pieces, and accessories. While some components MAY interchange between models/platforms made by different manufacturers, this commonality is by chance, not by design. Parts, pieces, and accessories manufactured by RRA and its vendors for the RRA LAR-8® platform are only to be used on the RRA LAR-8® and NOT on any other model/platform made by any other manufacturer, no matter how similar the rifles may be in appearance. Additionally, component parts, pieces, and accessories manufactured specifically for any other model/platform should never be used on the RRA LAR-8®. To do so risks damage to the rifle and injury or death to the shooter/bystanders. Any questions concerning the suitability of parts, pieces and accessories for the RRA LAR-8® should be directed to the RRA Sales/Customer Service Department at 866-980-7625 or info@rockriverarms.com.

RRA LAR-8® 7.308

## RRA LAR-8® Stand Alone Rear Sight Assembly



With A2 Rear Sight . . . . . 308A3305ASY \$110



## RRA LAR-8® A2 Carry Handle Assembly

With A2 Rear Sight . . . . . 308A0052CASY \$175



## RRA LAR-8® Tactical Mount

With A2 Rear Sight . . . . . 308A0125ASSY \$175



## RRA LAR-8® Dominator2 EO Tech Mount Assembly

With A2 Rear Sight . . . . . 308A0125FASSY \$175



## RRA LAR-8® Cleaning Station

Solid oak stand for cleaning the RRA LAR-8®.

308A0150 . . . . . \$50

## RRA LAR-8® .308 Caliber 20 Round Polymer Mags



308A0116T20 . . . . . \$25

## RRA LAR-8® .308 Caliber 3, 5, 10 Round Polymer Mags



3 Round Poly RRA LAR-8® Mag . . . . . 308A0116T03 \$35

5 Round Poly RRA LAR-8® Mag . . . . . 308A0116T05 \$35

10 Round Poly RRA LAR-8® Mag . . . . . 308A0116T10 \$35

**NOTE:** These are inch-pattern based LAR-8 magazines. No guarantee is made of their compatibility with any rifle other than the LAR-8. Due to the progressive improvements to the design of the LAR-8 magwell, some magazines may not drop freely from all LAR-8s and/or may require filing of the spacing tab.

## LULA .308 Caliber Mag Loader



Loads/unloads RRA LAR-8® mags and FAL inch/metric mags . . . . . 308A0119 \$31

## RRA LAR-8® Upper Receiver Vise Block



Heavy duty block designed specifically for the RRA LAR-8®.

308A3570 . . . . . \$55

## RRA LAR-8® Quad Rail Wrench Head



308A0162 . . . . . \$70

## .308 Caliber Dewey Cleaning Kit



Complete kit with nylon coated cable, 1/2 oz cleaner/lubricant, brushes, rods, patches, case remover, Cordura pouch and more. For 20 inch and shorter barrels.

308A3592 . . . . . \$42

# RRA LAR-6.8<sup>®</sup> CAR A4



## STANDARD CONFIGURATION

CALIBER	6.8mm Rem SPC II Chamber
UPPER RECEIVER	Forged A4 Upper
BARREL	16 Inch Chrome Moly, 1:10 Twist / Gas Block Sight Base
MUZZLE DEVICE	A2 Flash Hider / 5/8-24 Thread
TRIGGER	RRA Two Stage
BUTTSTOCK	RRA 6-Position Tactical CAR Stock
PISTOL GRIP / HANDGUARD	A2 Pistol Grip / CAR Handguard
WEIGHT / LENGTH	7.1 Pounds / 36 Inches
ACCURACY	1 MOA at 100 yds
INCLUDED	One Mag, RRA Case, Manual, Warranty

RRA  
Two Stage  
Trigger

RRA  
Tactical  
CAR Stock

CAR Length Gas System

*Shown with optional  
RRA Quad Rail Free Float,  
RRA Flip Front Sight Gas Block  
and RRA Operator CAR Stock*

## 6.8 SPC RRA LAR-6.8<sup>®</sup> CAR A4

Standard Configuration ..... SPC1850 **\$1,055**

## POPULAR OPTIONS AND UPGRADES

Substitute R-4 Handguard for CAR Handguard	<b>Add \$7</b>	Substitute Smith Vortex Flash Hider - 6.8 SPC	<b>Add \$88</b>
Substitute RRA Aluminum Free Float Tube	<b>Add \$65</b>	Substitute RRA Entry Buttstock	<b>No Charge</b>
Substitute Hogue Free Float Tube	<b>Add \$100</b>	Substitute RRA Operator A2 Stock	<b>Add \$50</b>
Substitute RRA Quad Rail Free Float with 3 Rail Covers	<b>Add \$145</b>	Substitute RRA Operator CAR Stock	<b>Add \$50</b>
Substitute A2 Front Sight Base	<b>No Charge</b>	Substitute Ambidextrous Charging Handle	<b>Add \$30</b>
Substitute Chrome Lined 1:10 Twist Barrel	<b>Add \$50</b>	Substitute RRA Winter Trigger Guard	<b>Add \$10</b>

**COMPLETE OPTIONS & UPGRADES LISTING ON PAGES 4 & 5**

## 6.8mm SPC CAR A4 Complete Upper Half

*Our 6.8 SPC Complete Upper Halves work with RRA LAR-15<sup>®</sup> and other lower halves, requiring only a 6.8 SPC magazine for proper function.*

**Includes Bolt Carrier Group  
and Charging Handle Assembly**

## STANDARD CONFIGURATION

CALIBER	6.8mm Rem SPC II Chamber
UPPER RECEIVER	Forged A4 Upper
BARREL	16 Inch Chrome Moly, 1:10 Twist / Gas Block Sight Base
MUZZLE DEVICE	A2 Flash Hider / 5/8-24 Thread
HANDGUARD	CAR Handguard



## 6.8 SPC CAR A4 Complete Upper Half

Standard Configuration ..... SPC0328B **\$595**





**RRA  
Tactical  
CAR Stock**

**RRA  
Two Stage  
Trigger**

# RRA LAR-6.8® Mid-Length A4

**Mid-Length Gas System**

*Shown with optional  
RRA Half Quad Rail,  
RRA Flip Front Sight Gas Block  
and RRA Operator CAR Stock*

## 6.8 SPC RRA LAR-6.8® Mid-Length A4

Standard Configuration ..... SPC1855 **\$1,055**

### STANDARD CONFIGURATION

CALIBER	6.8mm Rem SPC II Chamber
UPPER RECEIVER	Forged A4 Upper
BARREL	16 Inch Chrome Moly, 1:10 Twist / Gas Block Sight Base
MUZZLE DEVICE	A2 Flash Hider / 5/8-24 Thread
TRIGGER	RRA Two Stage
BUTTSTOCK	RRA 6-Position Tactical CAR Stock
GRIP / HANDGUARD	A2 Pistol Grip / Mid-Length Handguard
WEIGHT / LENGTH	7.1 Pounds / 36 Inches
ACCURACY	1 MOA at 100 yds
INCLUDED	One Mag, RRA Case, Manual, Warranty

### POPULAR OPTIONS AND UPGRADES

Substitute RRA Aluminum Free Float Tube	<b>Add \$65</b>	Substitute Smith Vortex Flash Hider - 6.8 SPC	<b>Add \$88</b>
Substitute RRA Quad Rail Free Float with 3 Rail Covers	<b>Add \$155</b>	Substitute RRA Entry Buttstock	<b>No Charge</b>
Substitute RRA Half Quad with Full Rail and 3 Rail Covers	<b>Add \$165</b>	Substitute RRA Operator A2 Stock	<b>Add \$50</b>
Substitute RRA Advanced Half Quad with 3 Rail Covers	<b>Add \$180</b>	Substitute RRA Operator CAR Stock	<b>Add \$50</b>
Substitute RRA Wraparound Quad with 3 Rail Covers	<b>Add \$195</b>	Substitute Ambidextrous Charging Handle	<b>Add \$30</b>
Substitute Chrome Lined 1:10 Twist Barrel	<b>Add \$50</b>	Substitute RRA Winter Trigger Guard	<b>Add \$10</b>

**COMPLETE OPTIONS & UPGRADES LISTING ON PAGES 4 & 5**

## 6.8mm SPC Mid-Length A4 Complete Upper Half

*Our 6.8 SPC Complete Upper Halves work with RRA LAR-15® and other lower halves, requiring only a 6.8 SPC magazine for proper function.*



## 6.8 SPC Mid-Length A4 Complete Upper Half

Standard Configuration ..... SPC0388B **\$595**

**Includes Bolt Carrier Group  
and Charging Handle Assembly**

### STANDARD CONFIGURATION

CALIBER	6.8mm Rem SPC II Chamber
UPPER RECEIVER	Forged A4 Upper
BARREL	16 Inch Chrome Moly, 1:10 Twist / Gas Block Sight Base
MUZZLE DEVICE	A2 Flash Hider / 5/8-24 Thread
HANDGUARD	Mid-Length Handguard



**RRA  
Operator  
A2 Stock**

**RRA Two Stage Match Trigger  
and RRA Winter Trigger Guard**

**Smith Vortex Flash Hider**

**Hogue Free Float Tube**

**Hogue  
Grip**

# RRA LAR-6.8<sup>®</sup> Coyote Carbine

## STANDARD CONFIGURATION

CALIBER	6.8mm Rem SPC II Chamber
UPPER RECEIVER	Forged A4 Upper
BARREL	16 Inch Chrome Moly HBAR, 1:10 Twist
MUZZLE DEVICE	Smith Vortex Flash Hider / 5/8-24 Thread
GAS BLOCK	Light Varmint Gas Block with Sight Rail
TRIGGER	RRA Two Stage
PISTOL GRIP / BUTTSTOCK	Hogue Rubber Grip / RRA Operator A2 Stock
HANDGUARD	Hogue Overmolded Free Float Tube, CAR Length
WEIGHT / LENGTH	7.0 Pounds / 36 Inches
ACCURACY	3/4 MOA at 100 yards
INCLUDED	One Mag, RRA Case, Manual, Warranty

## 6.8 SPC RRA LAR-6.8<sup>®</sup> Coyote Carbine

Standard Configuration ..... SPC1540 **\$1,270**

## POPULAR OPTIONS AND UPGRADES

Substitute RRA Quad Rail with 3 Rail Covers	<b>Add \$40</b>
Substitute RRA Overmolded A2 Pistol Grip	<b>No Charge</b>
Substitute Badger Tactical Latch on Charging Handle	<b>Add \$23</b>
Substitute BCMGunfighter Charging Handle	<b>Add \$25</b>
Substitute PRi Gas Buster Charging Handle	<b>Add \$65</b>
Substitute Ambidextrous Charging Handle	<b>Add \$30</b>
Substitute Ambidextrous Safety Selector	<b>Add \$25</b>

**COMPLETE OPTIONS & UPGRADES LISTING ON PAGES 4 & 5**

## 6.8mm SPC Coyote Carbine Complete Upper Half

*Our 6.8 SPC Complete Upper Halves work with RRA LAR-15<sup>®</sup> and other lower halves, requiring only a 6.8 SPC magazine for proper function. Includes Bolt Carrier Group and Charging Handle Assembly*

### STANDARD CONFIGURATION

CALIBER	6.8mm Rem SPC II Chamber
UPPER RECEIVER	Forged A4 Upper
BARREL	16 Inch Chrome Moly HBAR, 1:10 Twist
MUZZLE DEVICE	Smith Vortex Flash Hider / 5/8-24 Thread
HANDGUARD	Hogue Overmolded Free Float Tube, CAR Length



## 6.8mm SPC Coyote Carbine

Standard Configuration ..... SPC0590 **\$735**

## RRA LAR-6.8<sup>®</sup> Forged Lower Receiver

**Stripped**  
SPC0114RRA **\$140**

Assembly of a lower receiver requires proper high quality parts and appropriate tools and experience. It should only be undertaken under those conditions/circumstances.

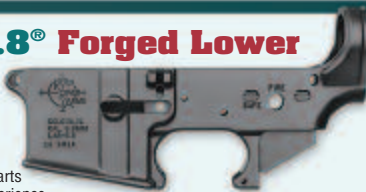

**Smith Vortex Flash Hider**  
6.8mm Rem SPC - 5/8-24 Thread  
308A0001V ..... **\$90**

**Smith Muzzle Brake**  
6.8mm Rem SPC - 5/8-24 Thread  
SPC0117S ..... **\$75**

## RRA LAR-6.8<sup>®</sup> Complete Lower Halves



**With RRA  
6-Position  
Tactical CAR Stock**

Standard Trigger ..... SPC0901C **\$325**  
RRA Two Stage Trigger ..... SPC0990C **\$415**

**RRA LAR-6.8<sup>®</sup> 6.8mm Rem SPC**

Chrome Moly  
Bull Barrel

RRA Aluminum Free Float Tube  
CAR Length Gas System

RRA  
Two Stage  
Trigger

# RRA LAR-458® CAR A4

*Shown with optional RRA Operator A2 Stock,  
RRA Winter Trigger Guard,  
Hogue Free Float Tube  
and Hogue Pistol Grip*

## RRA LAR-458® CAR A4

Standard Configuration ..... SOC1260 \$1,220

### Factory .458 SOCOM Ammunition Available

.458 SOCOM ammo is available in a variety of factory loads from SBR Ammunition. Not all loads are appropriate for the AR-platform. For more info, visit [www.SBRammunition.com](http://www.SBRammunition.com) or call 912-264-5822.

### STANDARD CONFIGURATION

CALIBER	.458 SOCOM Chamber
UPPER RECEIVER	Forged A4 Upper
BARREL	16 Inch Chrome Moly Bull Barrel, 1:14 Twist
MUZZLE DEVICE	A2 Flash Hider / 5/8-32 Thread
GAS BLOCK	Varmint Gas Block with Sight Rail
TRIGGER	RRA Two Stage
PISTOL GRIP	A2 Pistol Grip
BUTTSTOCK	A2 Buttstock
HANDGUARD	RRA Aluminum Free Float Tube, CAR Length
WEIGHT / LENGTH	7.6 Pounds / 36 Inches
ACCURACY	1.5 MOA at 100 Yards
INCLUDED	One Mag, RRA Case, Manual, Warranty

### POPULAR OPTIONS AND UPGRADES

Substitute Hogue Free Float Tube	Add \$30	Substitute RRA Operator CAR Stock	Add \$50
Substitute Low Profile Gas Block	Add \$20	Substitute RRA Operator A2 Stock	Add \$50
Substitute Smith Vortex Flash Hider - .458	Add \$88	Substitute ACE Skeleton Stock	Add \$22.50
Substitute RRA Overmolded A2 Pistol Grip	Add \$15	Substitute Badger Tactical Latch on Charging Handle	Add \$23
Substitute Hogue Rubber or ERGO SureGrip Pistol Grip	Add \$20	Substitute BCM Gunfighter Charging Handle	Add \$25
Substitute ERGO Tactical Deluxe Pistol Grip	Add \$55	Substitute PRI Gas Buster Charging Handle	Add \$65
Substitute RRA Entry Buttstock	No Charge	Substitute Ambidextrous Charging Handle	Add \$30
Substitute RRA 6-Position Tactical CAR Stock	Add \$5	Substitute RRA Winter Trigger Guard	Add \$10

COMPLETE OPTIONS & UPGRADES LISTING ON PAGES 4 & 5

## .458 SOCOM CAR A4 Complete Upper Half

RRA .458 SOCOM Upper Halves work with standard AR lower receivers and unmodified 30 round GI mags. Includes Bolt Carrier Group and Charging Handle Assembly

### STANDARD CONFIGURATION

CALIBER	.458 SOCOM Chamber
UPPER RECEIVER	Forged A4 Upper
BARREL	16 Inch Chrome Moly Bull Barrel, 1:14 Twist
MUZZLE DEVICE	A2 Flash Hider / 5/8-32 Thread
GAS BLOCK	Varmint Gas Block with Sight Rail
HANDGUARD	RRA Aluminum Free Float Tube, CAR Length



## .458 SOCOM CAR A4 Complete Upper Half

Standard Configuration ..... SOC0370 \$775

RRA LAR-458® .458 SOCOM





RRA Aluminum Free Float Tube  
Mid-Length Gas System

Chrome Moly  
Bull Barrel

RRA  
Two Stage  
Trigger

# RRA LAR-458® Mid-Length A4

Shown with optional RRA Operator CAR Stock,  
RRA Winter Trigger Guard, Star Safety  
and ERGO SureGrip



Add the  
RRA Hi-Rise  
Scope Mount

1 Inch ..... AR0130 \$50  
30mm ..... AR0131 \$50

## STANDARD CONFIGURATION

CALIBER	.458 SOCOM Chamber
UPPER RECEIVER	Forged A4 Upper
BARREL	16 Inch Chrome Moly Bull Barrel, 1:14 Twist
MUZZLE DEVICE	A2 Flash Hider / 5/8-32 Thread
GAS BLOCK	Varmint Gas Block with Sight Rail
TRIGGER	RRA Two Stage
PISTOL GRIP / BUTTSTOCK	A2 Pistol Grip / A2 Buttstock
HANDGUARD	RRA Aluminum Free Float Tube, Mid-Length
WEIGHT / LENGTH	7.8 Pounds / 36 Inches
ACCURACY	1.5 MOA at 100 Yards
INCLUDED	One Mag, RRA Case, Manual, Warranty

## RRA LAR-458® Mid-Length A4

Standard Configuration ..... SOC1261 \$1,220

## POPULAR OPTIONS AND UPGRADES

Substitute Low Profile Gas Block	Add \$20	Substitute RRA Operator CAR Stock	Add \$50
Substitute Smith Vortex Flash Hider	Add \$88	Substitute RRA Operator A2 Stock	Add \$50
Substitute Smith AWB Muzzle Brake	Add \$88	Substitute ACE Skeleton Stock	Add \$52.50
Substitute RRA Overmolded A2 Pistol Grip	Add \$15	Substitute Badger Tactical Latch on Charging Handle	Add \$23
Substitute Hogue Rubber or ERGO SureGrip Pistol Grip	Add \$20	Substitute BCM Gunfighter Charging Handle	Add \$25
Substitute ERGO Tactical Deluxe Pistol Grip	Add \$55	Substitute PRI Gas Buster Charging Handle	Add \$65
Substitute RRA Entry Buttstock	No Charge	Substitute Ambidextrous Charging Handle	Add \$30
Substitute RRA 6-Position Tactical CAR Stock	Add \$5	Substitute RRA Winter Trigger Guard	Add \$10

COMPLETE OPTIONS & UPGRADES LISTING ON PAGES 4 & 5

**.458 SOCOM Bolt Assembly** ..... SOC0034ASY \$160

## .458 SOCOM Mid-Length A4 Complete Upper Half

RRA .458 SOCOM Upper Halves work with standard AR lower receivers and unmodified 30 round GI mags.  
Includes Bolt Carrier Group and Charging Handle Assembly



## .458 SOCOM Mid-Length A4 Complete Upper Half

Standard Configuration ..... SOC0371 \$775

## STANDARD CONFIGURATION

CALIBER	.458 SOCOM Chamber
UPPER RECEIVER	Forged A4 Upper
BARREL	16 Inch Chrome Moly Bull Barrel, 1:14 Twist
MUZZLE DEVICE	A2 Flash Hider / 5/8-32 Thread
GAS BLOCK	Varmint Gas Block with Sight Rail
HANDGUARD	RRA Aluminum Free Float Tube, Mid-Length

RRA LAR-458® .458 SOCOM



**CAR A4 Operator**

SOC1278

# RRA LAR-458® Operator

Hogue Grip

RRA Operator CAR Stock



**Mid-Length A4 Operator SOC1276**

Half Quad Handguard style may vary from picture

Hogue Grip

RRA Two Stage Trigger

RRA Operator CAR Stock

## STANDARD CONFIGURATION

CALIBER / UPPER RECEIVER	.458 SOCOM Chamber / Forged A4
BARREL	16 Inch Chrome Moly Bull Barrel, 1:14 Twist
MUZZLE DEVICE	Smith Vortex Flash Hider / 5/8-32 Thread
GAS BLOCK	Varmint Gas Block with Sight Rail
TRIGGER	RRA Two Stage
PISTOL GRIP / STOCK	Hogue Grip / RRA Operator CAR Stock
WEIGHT / LENGTH : CAR	7.6 Pounds / 36 Inches
WEIGHT / LENGTH : MID-LENGTH	7.8 Pounds / 36 Inches
ACCURACY	1.5 MOA at 100 Yards
INCLUDED	One Mag, RRA Case, Manual, Warranty

COMPLETE OPTIONS & UPGRADES LISTING ON PAGES 4 & 5

## RRA LAR-458® CAR A4 Operator

With RRA Quad Rail Aluminum Free Float with 3 Ladder Rail Covers ..... SOC1278 **\$1,500**

## RRA LAR-458® Mid-Length A4 Operator

With RRA Half Quad Rail Free Float with Full Length Top Rail with 3 Ladder Rail Covers ..... SOC1276 **\$1,510**

# .458 SOCOM A4 Operator Complete Upper Halves



RRA .458 SOCOM Upper Halves work with standard AR lower receivers and unmodified 30 round GI mags. Includes Bolt Carrier Group and Charging Handle Assembly

## .458 SOCOM CAR A4 Operator

With RRA Quad Rail Aluminum Free Float ..... SOC0470 **\$990**



## .458 SOCOM Mid-Length A4 Operator

With RRA Half Quad Rail Free Float with Full Length Top Rail . . SOC0432 **\$995**

## STANDARD CONFIGURATION

CALIBER	.458 SOCOM Chamber
UPPER RECEIVER	Forged A4 Upper
BARREL	16 Inch Chrome Moly Bull Barrel, 1:14 Twist
MUZZLE DEVICE	Smith Vortex Flash Hider / 5/8-32 Thread
GAS BLOCK	Varmint Gas Block with Sight Rail

## RRA LAR-458® Forged Lower Receiver

Stripped  
SOC0114RRA **\$140**

Assembly of a lower receiver requires proper high quality parts and appropriate tools and experience. It should only be undertaken under those conditions/circumstances.

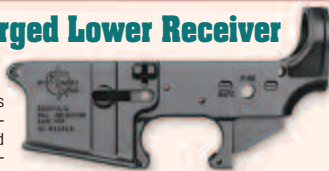

**Smith Vortex Flash Hider**  
.458 SOCOM - 5/8-32 Thread  
SOC0001V ..... **\$90**



**Smith Muzzle Brake**  
.458 SOCOM - 5/8-32 Thread  
SOC0117V ..... **\$90**

## RRA LAR-458® Complete Lower Halves



**With A2 Buttstock**  
Standard Trigger ..... SOC0900B **\$320**  
RRA Two Stage Trigger ..... SOC0940B **\$410**

**With RRA 6-Position Tactical CAR Stock**  
Standard Trigger ..... SOC0901C **\$335**  
RRA Two Stage Trigger ..... SOC0990C **\$425**



# RRA LAR-9<sup>®</sup> CAR A4

## STANDARD CONFIGURATION

CALIBER	9mm Luger Chamber
LOWER RECEIVER	Forged RRA LAR-9 <sup>®</sup> Lower with Integral Magwell
UPPER RECEIVER	Forged 9mm A4 Upper
BARREL	16 Inch Chrome Moly, 1:10 Twist / Gas Block Sight Base
MUZZLE DEVICE	A2 Flash Hider / 1/2-36 Thread
TRIGGER	Single Stage Trigger
HANDGUARD	R-4 Handguard
BUTTSTOCK / PISTOL GRIP	RRA 6-Position Tactical CAR Stock / Hogue Grip
WEIGHT / LENGTH	7.1 Pounds / 36 Inches
ACCURACY	1.5 inches at 50 yds
INCLUDED	One Mag, RRA Case, Manual, Warranty



*Shown with optional  
RRA Quad Rail Free Float,  
RRA Flip Front Sight Gas Block  
and RRA Operator CAR Stock*

**9mm RRA LAR-9<sup>®</sup> CAR A4**  
Standard Configuration . . . . . 9MM1850 **\$1,180**

## POPULAR OPTIONS AND UPGRADES

Substitute RRA Aluminum Free Float Tube	<b>Add \$65</b>	Substitute A2 Buttstock	<b>Add \$5</b>
Substitute Hogue Free Float Tube	<b>Add \$100</b>	Substitute RRA Operator CAR Stock	<b>Add \$50</b>
Substitute RRA Quad Rail Free Float with 3 Rail Covers	<b>Add \$145</b>	Substitute RRA Operator A2 Stock	<b>Add \$50</b>
Substitute A2 Front Sight Base	<b>No Charge</b>	Substitute Magpul PRS Stock	<b>Add \$225</b>
Substitute RRA Flip Front Sight Gas Block	<b>Add \$45</b>	Substitute Ambidextrous Charging Handle	<b>Add \$30</b>
Substitute RRA Overmolded A2 Pistol Grip	<b>No Charge</b>	Substitute Ambidextrous Safety Selector	<b>Add \$25</b>
Substitute RRA Entry Buttstock	<b>No Charge</b>	Substitute RRA Winter Trigger Guard	<b>Add \$10</b>

COMPLETE OPTIONS & UPGRADES LISTING ON PAGES 4 & 5

# 9mm CAR A4 Complete Upper Half

## STANDARD CONFIGURATION

CALIBER	9mm Luger Chamber
UPPER RECEIVER	Forged 9mm A4 Upper
BARREL	16 Inch Chrome Moly, 1:10 Twist / Gas Block Sight Base
MUZZLE DEVICE	A2 Flash Hider / 1/2-36 Thread
HANDGUARD	R-4 Handguard

Includes Bolt Carrier Group and Charging Handle Assembly



**9mm CAR A4** . . . . . 9MM0328B **\$575**

## 9MM CONVERSION INFO

In addition to the upper half, certain other parts are required to complete the 9mm conversion. A lower half with standard (non match/2-stage) internal parts is required, and a 9mm hammer must be installed in place of the .223 hammer. The 9mm magwell conversion block (which uses modified UZI magazines or Colt-style SMG magazines) is also required, if you are not using a dedicated RRA LAR-9<sup>®</sup> 9mm lower half with integral magwell. If using a CAR length receiver extension (as used in RRA collapsible CAR stocks as well as Entry stocks), the 9mm buffer replaces the CAR buffer. If using the standard receiver extension (as used in A1/A2 stocks and RRA non-collapsible CAR stocks), installation of the 9mm stock spacer, CAR action spring, and 9mm buffer is required. If you have any questions about 9mm conversions, please call Rock River Arms.

RRA LAR-9<sup>®</sup> 9MM CALIBER



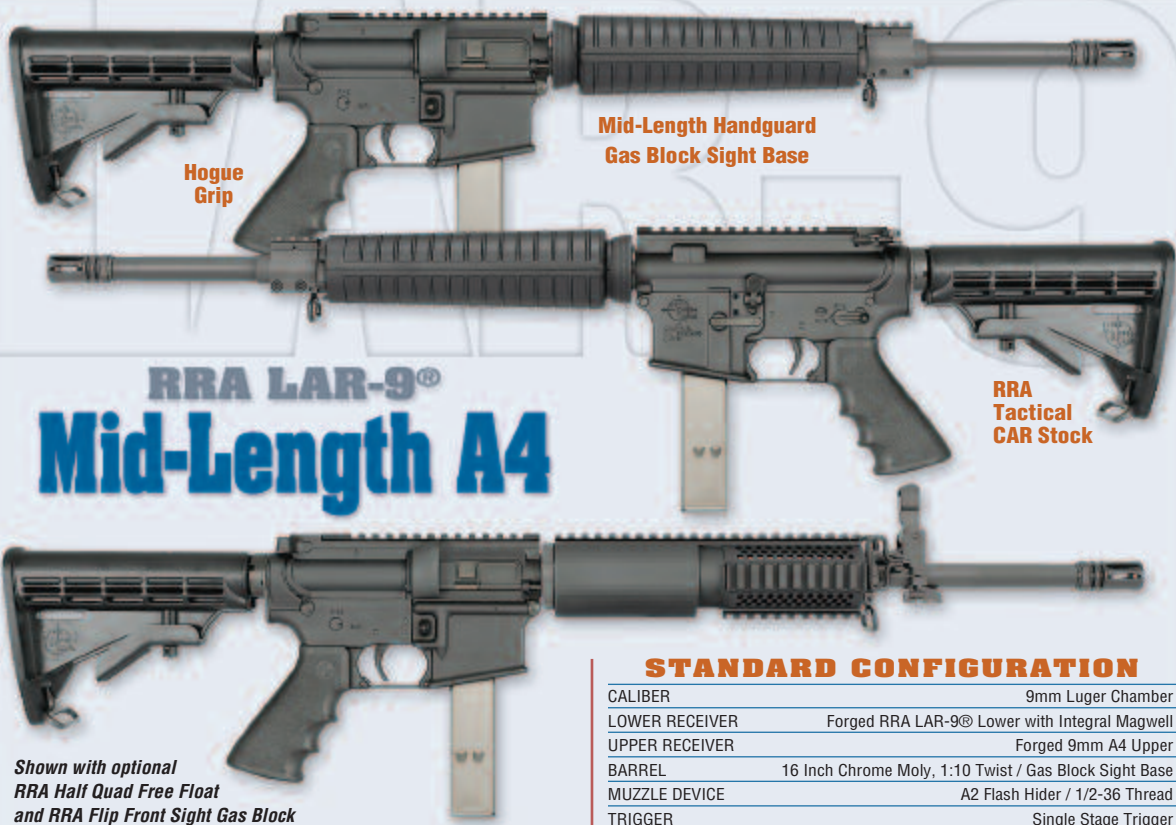

# RRA LAR-9® Mid-Length A4

*Shown with optional  
RRA Half Quad Free Float  
and RRA Flip Front Sight Gas Block*

**9mm RRA LAR-9® Mid-Length A4**  
Standard Configuration . . . . . 9MM1855 **\$1,180**

### STANDARD CONFIGURATION

CALIBER	9mm Luger Chamber
LOWER RECEIVER	Forged RRA LAR-9® Lower with Integral Magwell
UPPER RECEIVER	Forged 9mm A4 Upper
BARREL	16 Inch Chrome Moly, 1:10 Twist / Gas Block Sight Base
MUZZLE DEVICE	A2 Flash Hider / 1/2-36 Thread
TRIGGER	Single Stage Trigger
HANDGUARD	Mid-Length Handguard
BUTTSTOCK / PISTOL GRIP	RRA 6-Position Tactical CAR Stock / Hogue Grip
WEIGHT / LENGTH	7.1 Pounds / 36 Inches
ACCURACY	1.5 inches at 50 yds
INCLUDED	One Mag, RRA Case, Manual, Warranty

### POPULAR OPTIONS AND UPGRADES

Substitute RRA Aluminum Free Float Tube	<b>Add \$65</b>	Substitute RRA Operator CAR Stock	<b>Add \$50</b>
Substitute RRA Quad Rail Free Float with 3 Rail Covers	<b>Add \$155</b>	Substitute RRA Operator A2 Stock	<b>Add \$50</b>
Substitute RRA Half Quad Free Float with 3 Rail Covers	<b>Add \$165</b>	Green Furniture on Rifle	<b>Add \$10</b>
Substitute RRA Advanced Half Quad with 3 Rail Covers	<b>Add \$180</b>	Green Furniture on Upper Half	<b>Add \$5</b>
Substitute RRA Wraparound Quad with 3 Rail Covers	<b>Add \$195</b>	Substitute Badger Tactical Latch on Charging Handle	<b>Add \$23</b>
Substitute RRA Overmolded A2 Pistol Grip	<b>No Charge</b>	Substitute BCM Gunfighter Charging Handle	<b>Add \$25</b>
Substitute ERGO SureGrip Pistol Grip	<b>No Charge</b>	Substitute PRI Gas Buster Charging Handle	<b>Add \$65</b>
Substitute ERGO Tactical Deluxe Pistol Grip	<b>Add \$45</b>	Substitute Ambidextrous Charging Handle	<b>Add \$30</b>

COMPLETE OPTIONS & UPGRADES LISTING ON PAGES 4 & 5

## 9mm Mid-Length A4 Complete Upper Half

Includes Bolt Carrier Group and Charging Handle Assembly



**9mm Mid-Length A4** . . . . . 9MM0388B **\$575**

### STANDARD CONFIGURATION

CALIBER	9mm Luger Chamber
UPPER RECEIVER	Forged 9mm A4 Upper
BARREL	16 Inch Chrome Moly, 1:10 Twist / Gas Block Sight Base
MUZZLE DEVICE	A2 Flash Hider / 1/2-36 Thread
HANDGUARD	Mid-Length Handguard

All NFA rules apply.

# RRA LAR-9® 7 Inch A4 Pistol



RRA Aluminum  
Free Float Tube

Hogue  
Grip



Shown with optional  
RRA Quad Rail Free Float



Shown with optional  
A2 Upper Receiver and  
A2 Front Sight Base

## 9mm RRA LAR-9® 7 Inch A4 Pistol

Standard Configuration . . . . . 9MM2110 **\$1,210**

### STANDARD CONFIGURATION

CALIBER	9mm Luger Chamber
LOWER RECEIVER	Forged RRA LAR-9® Lower with Integral Magwell
UPPER RECEIVER	Forged 9mm A4 Upper
BARREL	7 Inch Chrome Moly, 1:10 Twist / A2 Flash Hider / 1/2-36 Thread
GAS BLOCK	Gas Block Sight Base
TRIGGER	Single Stage
PISTOL GRIP	Hogue Rubber Grip
HANDGUARD	RRA Aluminum Free Float Tube, Pistol Length
WEIGHT / LENGTH	4.8 Pounds / 23 Inches
INCLUDED	One Mag, Manual, Warranty

### POPULAR OPTIONS AND UPGRADES

Substitute RRA Quad Rail Free Float with 3 Rail Covers	<b>Add \$75</b>
Substitute Low Profile Gas Block	<b>No Charge</b>
Substitute RRA Flip Front Sight Gas Block	<b>Add \$45</b>
Substitute BCM Gunfighter Charging Handle	<b>Add \$25</b>
Substitute PRI Gas Buster Charging Handle	<b>Add \$65</b>
Substitute Ambidextrous Charging Handle	<b>Add \$30</b>
Substitute Ambidextrous Safety Selector	<b>Add \$25</b>
Substitute RRA Winter Trigger Guard	<b>Add \$10</b>

COMPLETE OPTIONS & UPGRADES LISTING ON PAGES 4 & 5

# 9mm 7 Inch A4 Pistol Complete Upper Half

For Pistol and SBR applications only - all NFA rules apply.

Includes Bolt Carrier Group and Charging Handle Assembly

### STANDARD CONFIGURATION

CALIBER	9mm Luger Chamber
UPPER RECEIVER	Forged 9mm A4 Upper
BARREL	7 Inch Chrome Moly, 1:10 Twist
MUZZLE DEVICE	A2 Flash Hider / 1/2-36 Thread
FRONT SIGHT BASE	Gas Block Sight Base
HANDGUARD	RRA Aluminum Free Float Tube, Pistol Length



## 9mm 7 Inch A4 Pistol Complete Upper Half

Standard Configuration . . . . . 9MM0363B **\$630**

RRA LAR-9® 9MM CALIBER

All NFA rules apply.



Hogue Grip

# RRA LAR-9® 10.5 Inch A4 Pistol

*Shown with optional RRA Wraparound Half Quad, RRA Flip Front Sight Gas Block and A.R.M.S. Flip Rear Sight*

*Shown with optional RRA Quad Rail Free Float, RRA Flip Front Sight Gas Block and RRA Tactical Mount*

### POPULAR OPTIONS AND UPGRADES

Substitute RRA Aluminum Free Float Tube	Add \$65
Substitute Hogue Free Float Tube	Add \$100
Substitute RRA Quad Rail Free Float with 3 Rail Covers	Add \$145
Substitute Low Profile Gas Block	No Charge
Substitute BCMGunfighter Charging Handle	Add \$25
Substitute Ambidextrous Charging Handle	Add \$30
Substitute Ambidextrous Safety Selector	Add \$25
Substitute RRA Flip Front Sight Gas Block	Add \$45
Substitute RRA Winter Trigger Guard	Add \$10

COMPLETE OPTIONS & UPGRADES LISTING ON PAGES 4 & 5

## 9mm RRA LAR-9® 10.5 Inch A4 Pistol

Standard Configuration . . . . . 9MM2120 \$1,160

### STANDARD CONFIGURATION

CALIBER	9mm Luger Chamber	
LOWER RECEIVER	Forged RRA LAR-9® Lower with Integral Magwell	
UPPER RECEIVER	Forged 9mm A4 Upper	
BARREL	10.5 Inch Chrome Moly, 1:10 Twist / A2 Flash Hider / 1/2-36 Thread	
GAS BLOCK	Gas Block Sight Base	
TRIGGER	Single Stage	
PISTOL GRIP	Hogue Rubber Grip	
HANDGUARD	R-4 Handguard	
WEIGHT / LENGTH	4.9 Pounds / 26.5 Inches	
INCLUDED	One Mag, Manual, Warranty	

## 9mm 10.5 Inch A4 Pistol Complete Upper Half

For Pistol and SBR applications only - all NFA rules apply.  
Includes Bolt Carrier Group and Charging Handle Assembly



### 9mm 10.5 Inch A4 Pistol Complete Upper Half

Standard Configuration . . . . . 9MM0362B \$585

### STANDARD CONFIGURATION

CALIBER	9mm Luger Chamber	
UPPER RECEIVER	Forged 9mm A4 Upper	
BARREL	10.5 Inch Chrome Moly, 1:10 Twist	
MUZZLE DEVICE	A2 Flash Hider / 1/2-36 Thread	
FRONT SIGHT BASE	Gas Block Sight Base	
HANDGUARD	R-4 Handguard	



## 9mm Conversion Parts

### 9mm Forged A4 Upper Receiver Assembly



Complete with port door and case deflector.

9MM0052BASY ..... \$175

### 9mm Forged A2 Upper Receiver Assembly



Complete with rear sight,  
port door and case deflector

9MM0052AASY \$195

### 9mm PRI Gas Buster Charging Handle With Big Latch

9MM0026GBASY \$100



### 9mm Chrome Moly Barrel Assemblies

9mm Luger chamber, 1:10 twist, 1/2-36 threaded muzzle, with barrel nut, handguard cap, front sight housing with bayonet lug.

10.5 Inch CAR ..... 9MM0225ASY \$205

16 Inch CAR ..... 9MM0201ASY \$205

16 Inch Mid-Length ..... 9MM0203ASY \$205



### 9mm A2 Flash Hider

1/2-36 Thread ..... 9MM0001 \$12.50



### 9mm Military Style Muzzle Brake

1/2-36 Thread ..... 9MM0117 \$35



### 9mm Smith Vortex Flash Hider

1/2-36 Thread ..... 9MM0001V \$57.50



### 9mm Ejection Port Door

9MM0048 ..... \$9



### 9mm Port Door Kit

9MM0048K ..... \$11

### 9mm Case Deflector

Black, with spring ..... 9MM0042B \$12

Green, with spring ..... 9MM0042G \$12



### RRA LAR-9® 9mm Forged Lower Receiver Assembly

**With Integral 9mm Magwell** Includes 9mm marked lower receiver, feed ramp, 9mm ejector, 9mm bolt catch, mag catch, spring and button ..... 9MM0114ASY \$300

Assembly of a lower receiver requires proper high quality parts and appropriate tools and experience. It should only be undertaken under those conditions/circumstances.



### RRA LAR-9® 9mm Complete Lower Halves

**With Integral 9mm Magwell**

Includes 9mm marked lower and all necessary conversion parts.

With A2 Buttstock ..... 9MM0900B \$475

With 6-Position Tactical Stock ..... 9MM0901C \$490

### 9mm Single Stage Trigger Kit

Semi-auto ..... 9MM0093K \$40

### 9mm Bolt Carrier Assembly

Complete Assembly ..... 9MM0032ASY \$175

9mm Hammer ..... 9MM0106 \$20

9mm Firing Pin ..... 9MM0027 \$12

9mm Firing Pin Spring ..... 9MM0027S \$2

9mm Bolt Carrier Key ..... 9MM0029 \$20

9mm Extractor ..... 9MM0037 \$25

9mm Extractor Pin ..... 9MM0038 \$1

9mm Ejector ..... 9MM0041 \$8

9mm Bolt Catch Only for use in 9mm Lower Assembly  
WITH integral Magwell ..... 9MM0103 \$8.50

9mm Stock Spacer ..... 9MM0073 \$8



### 9mm Magwell Conversion Block

For lower receivers WITHOUT integral magwell.

9MM0115 ..... \$175

9mm Buffer ..... 9MM0107 \$25

9mm CAR Action Spring  
AR0072A ..... \$4



Hogue Grip

R-4 Handguard Gas Block Sight Base

RRA Tactical CAR Stock

# RRA LAR-40® CAR A4

Shown with optional RRA Quad Rail Free Float, A2 Front Sight Base and RRA Operator CAR Stock

## .40 S&W RRA LAR-40® CAR A4

Standard Configuration . . . . . 4S1850 **\$1,260**

### STANDARD CONFIGURATION

CALIBER	.40 S&W Chamber
LOWER RECEIVER	Forged RRA LAR-40® Lower with Integral Magwell
UPPER RECEIVER	Forged .40 S&W A4 Upper
BARREL	16 Inch Chrome Moly, 1:16 Twist / Gas Block Sight Base
MUZZLE DEVICE	A2 Flash Hider / 5/8-32 Thread
TRIGGER	Single Stage Trigger
HANDGUARD	R-4 Handguard
BUTTSTOCK / PISTOL GRIP	RRA 6-Position Tactical CAR Stock / Hogue Grip
WEIGHT / LENGTH	7.1 Pounds / 36 Inches
ACCURACY	1.5 inches at 50 yds
INCLUDED	One Mag, RRA Case, Manual, Warranty

### POPULAR OPTIONS AND UPGRADES

Substitute RRA Aluminum Free Float Tube	<b>Add \$65</b>	Substitute A2 Buttstock	<b>Add \$5</b>
Substitute Hogue Free Float Tube	<b>Add \$100</b>	Substitute RRA Operator CAR Stock	<b>Add \$50</b>
Substitute RRA Quad Rail Free Float with 3 Rail Covers	<b>Add \$145</b>	Substitute RRA Operator A2 Stock	<b>Add \$50</b>
Substitute A2 Front Sight Base	<b>No Charge</b>	Substitute Magpul PRS Stock	<b>Add \$225</b>
Substitute RRA Flip Front Sight Gas Block	<b>Add \$45</b>	Substitute Ambidextrous Charging Handle	<b>Add \$30</b>
Substitute RRA Overmolded A2 Pistol Grip	<b>No Charge</b>	Substitute Ambidextrous Safety Selector	<b>Add \$25</b>
Substitute RRA Entry Buttstock	<b>No Charge</b>	Substitute RRA Winter Trigger Guard	<b>Add \$10</b>

COMPLETE OPTIONS & UPGRADES LISTING ON PAGES 4 & 5

# .40 S&W CAR A4 Complete Upper Half

Includes Bolt Carrier Group and Charging Handle Assembly



**.40 S&W CAR A4** . . . . . 4S0328B **\$640**

### STANDARD CONFIGURATION

CALIBER	.40 S&W Chamber
UPPER RECEIVER	Forged .40 S&W A4 Upper
BARREL	16 Inch Chrome Moly, 1:16 Twist / Gas Block Sight Base
MUZZLE DEVICE	A2 Flash Hider / 5/8-32 Thread
HANDGUARD	R-4 Handguard



**RRA LAR-40®**  
**Mid-Length A4**

*Shown with optional  
 RRA Half Quad Free Float  
 and RRA Flip Front Sight Gas Block*

**.40 S&W**  
**RRA LAR-40® Mid-Length A4**  
 Standard Configuration . . . . . 4S1855 **\$1,260**

**STANDARD CONFIGURATION**

CALIBER	.40 S&W Chamber
LOWER RECEIVER	Forged RRA LAR-40® Lower with Integral Magwell
UPPER RECEIVER	Forged .40 S&W A4 Upper
BARREL	16 Inch Chrome Moly, 1:16 Twist / Gas Block Sight Base
MUZZLE DEVICE	A2 Flash Hider / 5/8-32 Thread
TRIGGER	Single Stage Trigger
HANDGUARD	Mid-Length Handguard
BUTTSTOCK / PISTOL GRIP	RRA 6-Position Tactical CAR Stock / Hogue Grip
WEIGHT / LENGTH	7.1 Pounds / 36 Inches
ACCURACY	1.5 inches at 50 yds
INCLUDED	One Mag, RRA Case, Manual, Warranty

**POPULAR OPTIONS AND UPGRADES**

Substitute RRA Aluminum Free Float Tube	<b>Add \$65</b>	Substitute RRA Operator CAR Stock	<b>Add \$50</b>
Substitute RRA Quad Rail Free Float with 3 Rail Covers	<b>Add \$155</b>	Substitute RRA Operator A2 Stock	<b>Add \$50</b>
Substitute RRA Half Quad Free Float with 3 Rail Covers	<b>Add \$165</b>	Green Furniture on Rifle	<b>Add \$10</b>
Substitute RRA Advanced Half Quad with 3 Rail Covers	<b>Add \$180</b>	Green Furniture on Upper Half	<b>Add \$5</b>
Substitute RRA Wraparound Quad with 3 Rail Covers	<b>Add \$195</b>	Substitute Badger Tactical Latch on Charging Handle	<b>Add \$23</b>
Substitute RRA Overmolded A2 Pistol Grip	<b>No Charge</b>	Substitute BCM Gunfighter Charging Handle	<b>Add \$25</b>
Substitute ERGO SureGrip Pistol Grip	<b>No Charge</b>	Substitute PRI Gas Buster Charging Handle	<b>Add \$65</b>
Substitute ERGO Tactical Deluxe Pistol Grip	<b>Add \$45</b>	Substitute Ambidextrous Charging Handle	<b>Add \$30</b>

**COMPLETE OPTIONS & UPGRADES LISTING ON PAGES 4 & 5**

**.40 S&W Mid-Length A4 Complete Upper Half**

**STANDARD CONFIGURATION**

CALIBER	.40 S&W Chamber
UPPER RECEIVER	Forged .40 S&W A4 Upper
BARREL	16 Inch Chrome Moly, 1:16 Twist / Gas Block Sight Base
MUZZLE DEVICE	A2 Flash Hider / 5/8-32 Thread
HANDGUARD	Mid-Length Handguard

**Includes Bolt Carrier Group and Charging Handle Assembly**



**.40 S&W Mid-Length A4** . . . . . 4S0388B **\$640**



# Barrel Assembly Parts

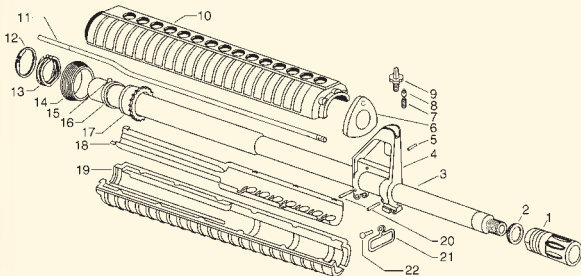

1	<b>Flash Hiders/Muzzle Brakes</b>	See right
2C	Crush washer	AR0002C \$2.75
3	<b>Barrels</b>	See Page 65
4D	Front sight housing, with bayonet lug	AR0004D \$35.00
4B	Front sight housing, w/out bayo lug	AR0004B \$35.00
4NM	Front sight housing, NM	AR0004NM \$35.00
5	Gas tube roll pin	AR0005 \$5.00
6A	Handguard cap, round	AR0006A \$2.00
6B	Handguard cap, triangle	AR0006B \$2.00
7	Front sight detent spring	AR0007 \$5.00
8	Front sight detent	AR0008 \$.75
9	Front sight post, square	AR0009 \$3.00
10	<b>Handguards</b>	See Pages 74 and 75
11A	Gas tube, CAR	AR0011A \$12.00
11B	Gas tube, standard	AR0011B \$13.00
11C	Gas tube, mid-length	AR0011C \$13.00
11NM	Gas tube, NM	AR0011NM \$13.00
11P	Gas tube, pistol	AR0011P \$12.00
12	Handguard snap ring	AR0012 \$1.00
13	Weld spring	AR0013 \$4.50
14	Delta ring	AR0014 \$6.00
15	Barrel indexing pin	AR0015 \$2.00
16	Barrel extension, .223	AR0016 \$22.50
17	Barrel nut, standard	AR0017 \$6.50
17NM	Barrel nut, NM	AR0017NM \$25.00
18	Handguard liner, each (2 required)	AR0018 \$3.00
20	Front sight taper pin, each (2 required)	AR0020TAP \$3.00
20	Front sight dowel pin, each (2 required)	AR0020DOW \$3.00
21	Front sling swivel	AR0021 \$3.50
22	Front sling swivel rivet	AR0022 \$1.00

**Delta Ring Kit** Includes delta ring, weld spring and handguard snap ring ..... AR0014K **\$10**



**Side Mount Sling Swivel**  
Mounts to barrel ..... AR0161 **\$27**

**Front Sight Accessory Mount**  
AR0159 ..... **\$40**

**A2 Front Sight Tool**  
Four prong ..... AR0163 **\$7**

## Gas Block Sight Base

For .750 diameter barrels  
AR0122ASY ..... **\$46**

## Low Profile Gas Blocks

For .750 diameter barrels  
AR0122LPASY ..... **\$35**  
For Varmint/Bull barrels  
AR0122LPVASY ..... **\$45**

## Varmint Gas Block with Sight Rail

For Varmint/Bull barrels  
AR0122VASV ..... **\$45**  
**Light Varmint Gas Block**  
for .750 diameter barrels  
AR0122LVASY ..... **\$45**



**See Page 46 for RRA LAR-8® Gas Blocks**

## Flash Hiders & Brakes .223/5.56



**A1 Flash Hider**  
1/2-28 Thread ..... AR0001A1 **\$7.50**

**A2 Flash Hider**  
1/2-28 Thread ..... AR0001A2 **\$6.50**

**Tactical Muzzle Brake**  
AWB Compliant  
1/2-28 Thread ..... AR0117T **\$35**

**Military Style Muzzle Brake**  
AWB Compliant  
1/2-28 Thread ..... AR0117MS **\$35**

**Long A2 Flash Hider**  
Ideal for bringing a 14.5" barrel to legal 16" minimum when permanently mounted.  
1/2-28 Thread ..... AR0001A2L **\$25**

**Tactical Long A2 Flash Hider**  
1/2-28 Thread ..... AR0001A2LT **\$30**

## Smith Vortex Flash Hider

.223/5.56mm 1/2-28 Thread  
Designed to make the SEI Sound Suppressor easier to remove, with shallower pitch and grooves to reduce surface contact ..... AR0001V **\$57.50**

**RRA Directionally-Tuned and Ported Muzzle Brake**  
.223/5.56mm 1/2-28 Thread  
AR0117P ..... **\$110**



## Chrome Moly Barrel Assemblies



**5.56mm NATO chamber**, 1:9 twist, 1/2-28 threaded muzzle, with barrel nut, handguard cap, front sight housing with bayonet lug.

**7" Pistol Heavy, 1:9 Twist** ..... AR0209ASY **\$210**

**10.5" CAR Heavy, 1:7 Twist** ..... AR0225ASY **\$210**

**With Chrome Lined Bore/Chamber** ..... AR0241ASY **\$255**

**14.5" CAR Medium Weight**

**With Chrome Lined Bore/Chamber** ..... AR0199ASY **\$255**

**16" CAR Heavy** ..... AR0200ASY **\$210**

**With Chrome Lined Bore/Chamber** ..... AR0200CLASY **\$255**

**16" Mid-Length Heavy** ..... AR0210ASY **\$210**

**With Chrome Lined Bore/Chamber** ..... AR0212ASY **\$255**



**5.56mm NATO chamber**, R-4 profile, 1:9 twist, 1/2-28 threaded muzzle, with barrel nut, handguard cap, front sight housing, bayonet lug.

**16" R-4 Heavy** ..... AR0202ASY **\$210**

**With Chrome Lined Bore/Chamber** ..... AR0204ASY **\$255**



**.223 Wylde chamber**, 1:9 twist, 1/2-28 threaded muzzle, with barrel nut, handguard cap, front sight housing with bayonet lug.

**20" Standard Heavy** ..... AR0220ASY **\$220**

**With Chrome Lined Bore/Chamber** ..... AR0221ASY **\$265**

## Stainless Steel Barrel Assemblies

**Air-Gauged**



**.223 Wylde chamber**, 1:8 twist, 1/2-28 threaded muzzle, with barrel nut, handguard cap, front sight housing with bayonet lug.

**16" Mid-Length Heavy** ..... AR0215ASY **\$255**

**20" Standard Heavy** ..... AR0222ASY **\$270**

**18" Mid-Length Heavy**

**With Low Profile Gas Block** ..... AR0230ASY **\$300**

## Chrome Moly Barrel Assemblies Lightweight Barrels

RRA's Lightweight Barrels are .5 to .8 pounds lighter than their heavy barrel counterparts!

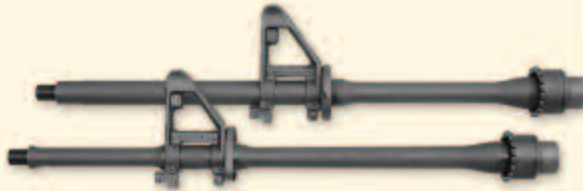

**5.56mm NATO chamber**, 1:9 twist, 1/2-28 threaded muzzle, with barrel nut, handguard cap, front sight housing with bayonet lug.

**16" CAR Lightweight**  
**With Chrome Lined Bore/Chamber** ..... AR0232CLASY **\$255**

**16" Mid-Length Lightweight**  
**With Chrome Lined Bore/Chamber** ..... AR0213CLASY **\$255**



**5.56mm NATO chamber**, R-4 profile, 1:9 twist, 1/2-28 threaded muzzle, with barrel nut, handguard cap, front sight housing with bayonet lug.

**14.5" R-4 Lightweight, 1:7 Twist**  
**With Chrome Lined Bore/Chamber** ..... AR0197ASY **\$255**

**16" R-4 Lightweight, 1:9 Twist**  
**With Chrome Lined Bore/Chamber** ..... AR0219ASY **\$255**

## Stainless Steel Varmint Barrels

**Air-Gauged - Cryogenically Treated**

**.223 Wylde chamber**, with Varmint Gas Block with Sight Rail.  
Barrel Diameter .920 in front of gas block, 1.050 under handguard.

**16" Varmint, 1:8 Twist** ..... AR0208ASY **\$280**

**18" Varmint, 1:8 Twist** ..... AR0218ASY **\$290**

**20" Varmint, 1:8 Twist** ..... AR0226ASY **\$300**

**24" Varmint, 1:8 Twist** ..... AR0228ASY **\$310**

**24" Varmint, 1:12 Twist** ..... AR0229ASY **\$310**

# LAR-15® Upper Receiver Parts

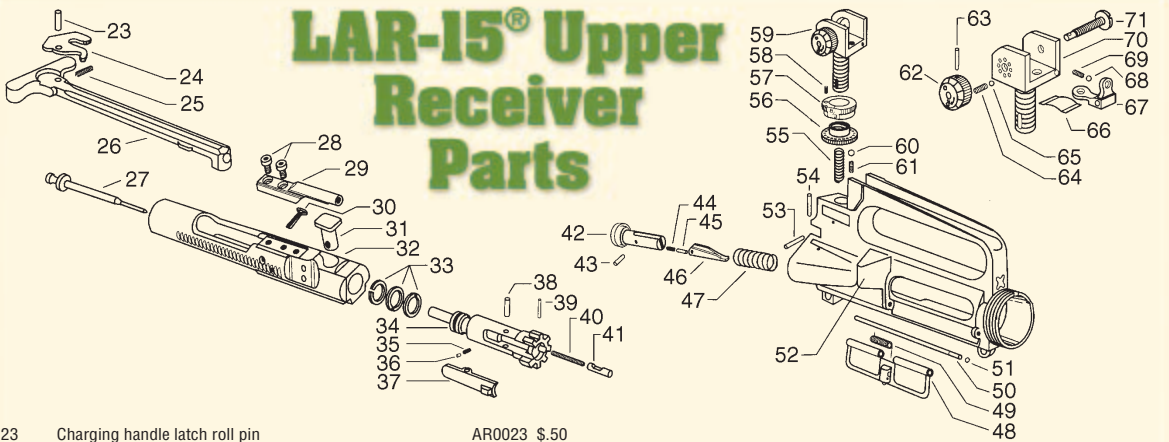

23	Charging handle latch roll pin	AR0023	\$ .50	50	Ejection port cover pin	AR0050	\$ 1.00
24	Charging handle latch	AR0024	\$ 2.50	51	Pin retaining ring	AR0051	\$ .50
25	Charging handle latch spring	AR0025	\$ .50	52	<b>Upper Receivers</b>	See Page 67	
26	Charging handle	AR0026	\$ 21.00	53	Rear sight elevation spring pin	AR0053	\$ .50
27B	Firing pin	AR0027B	\$ 7.50	54	Forward assist spring pin	AR0054	\$ .50
28	Bolt carrier key screw, each (2 required)	AR0028	\$ 1.00	55	Rear sight elevation spring	AR0055	\$ .50
29	Bolt carrier key	AR0029	\$ 11.50	56	Rear sight elevation knob	AR0056	\$ 5.50
30	Firing pin retaining pin	AR0030	\$ 1.00	56NM	Rear sight elevation index knob, NM 1 piece	AR0056/57NM	\$ 20
31	Cam pin	AR0031	\$ 5.00	57	Rear sight elevation index	AR0057	\$ 5.50
32A	Bolt carrier, semi-auto	AR0032A	\$ 70.00	58	Index screw	AR0058	\$ 1.75
33	Bolt gas ring, each (3 required)	AR0033	\$ .67	59	Rear sight assembly	AR0059	\$ 35.00
34	Bolt	AR0034	\$ 37.50	60	Ball bearing	AR0060	\$ .50
34ASY	<b>Bolt Assembly</b>	AR0034ASY	\$ 60.00	61	Elevation index spring	AR0061	\$ .50
35	Extractor spring	AR0035	\$ .50	62	Rear sight windage knob	AR0062	\$ 6.00
36	Extractor spring insert	AR0036	\$ .50	62LK	Rear sight windage knob, lockable	AR0062LK	\$ 8.00
37	Extractor	AR0037	\$ 14.00	62LKS	Lockable knob locking screw	AR0062LKS	\$ 1.50
38	Extractor pin	AR0038	\$ 1.00	63	Rear sight windage knob pin	AR0063	\$ .50
39	Ejector roll pin	AR0039	\$ .50	64	Rear sight index spring	AR0064	\$ .50
40	Ejector spring	AR0040	\$ .50	65	Rear sight ball bearing	AR0065	\$ .50
41	Ejector	AR0041	\$ 1.50	66	Rear sight flat spring	AR0066	\$ .75
42	<b>Forward Assist Assembly</b>	AR0042ASY	\$ 12.00	67	Rear sight aperture	AR0067	\$ 6.50
43	Pawl spring pin	AR0043	\$ .50	68	Rear sight ball bearing	AR0068	\$ .50
44	Pawl spring	AR0044	\$ .50	69	Rear sight helical spring	AR0069	\$ .50
45	Pawl detent	AR0045	\$ 1.25	70	Rear sight base	AR0070	\$ 18.00
46	Forward assist pawl	AR0046	\$ 4.00	70NM	Rear sight base, NM	AR0070NM	\$ 26.00
47	Forward assist spring	AR0047	\$ 1.00	71	Rear sight windage screw	AR0071	\$ 3.00
48	Ejection port cover	AR0048	\$ 6.00	71NM	Rear sight windage screw, NM	AR0071NM	\$ 6.00
49	Ejection port cover spring	AR0049	\$ .50				

**Forward Assist Kit**  
AR0042K . . \$13.50

**Accu-Wedge Buffer**

**Ejection Port Door Kit**  
AR0048K . . \$8

**A2 Rear Sight Kit**  
AR0070STDKIT . \$65

Drop-in installation, eliminates play between the upper and lower receiver. You won't need one on your RRA rifle, but why not buy one for a friend?  
AR0190 . . . \$6

**RRA LAR-15® Bolt Rebuild Kit**  
All the parts necessary to rebuild the bolt assembly.  
AR3258 . . . \$30



# RRA Forged Upper Receiver Assemblies



## A2 Upper Receiver Assembly

Complete with rear sight, forward assist and port door.

**Complete** ..... AR0052AASY \$190

**Stripped A2 Upper Receiver** ..... AR0052A \$125

## Match A2 Upper Receiver Assembly

Complete with forward assist, port door and Match Rear Sight - 1/4 x 1/4 min or 1/2 x 1/2 min, with .030 or .040 hooded aperture.

AR0052ANMASY ..... \$225

**UTE2 - Universal Tactical Entry**  
With integral rear sight and the same rail height as an A4 upper!

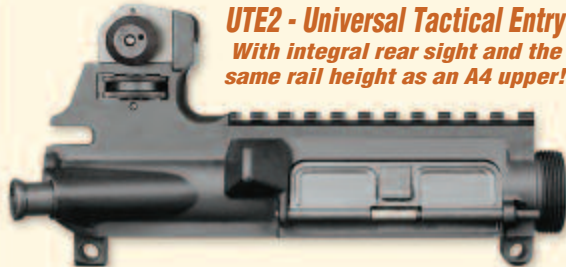

## UTE2 Upper Receiver Assembly

Complete with rear sight, forward assist and port door.

**Complete** ..... AR0052UASY \$225

**Stripped UTE2 Upper Receiver** ..... AR0052U \$165



## Complete Bolt Carrier Group

Semi-auto ..... AR0032AGRP \$130

**Chromed** - Semi-auto ..... AR0032AGRPC \$170

## CAT M-4 Bolt Tool

Tool to clean and maintain standard LAR-15/LAR-6.8/LAR-458 bolts and carriers. Can be used to clean carbon off the bolt tail, the interior of the carrier and the firing pin. With 1/4 inch Hex Head and Patch Hole.

**CAT M-4 Bolt Tool** ..... AR3550 \$36

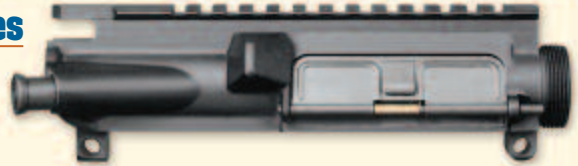

## A4 Upper Receiver Assembly

Complete with forward assist and port door.

**Complete** ..... AR0052BASY \$145

**Stripped A4 Upper Receiver** ..... AR0052B \$125

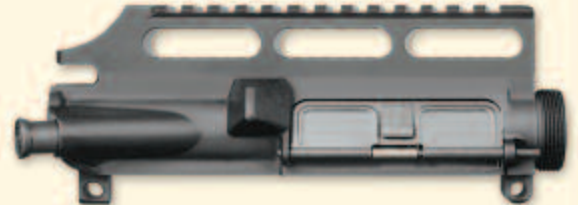

## EOP Upper Receiver Assembly

Elevated Optical Platform - with rail height 3/4" taller than an A4 upper!

Complete with forward assist and port door.

**Complete** ..... AR0052EASY \$165

**Stripped EOP Upper Receiver** ..... AR0052E \$150

## RRA Forged Charging Handle Assembly

AR0026ASY ... \$25

## RRA Forged Ambidextrous Charging Handle Assembly

AR0026ASYAMBI ... \$60

## BCMGUNFIGHTER Charging Handle

BCMGunfighter - Small Latch ..... AR0026GFSASY \$48

BCMGunfighter - Medium Latch ..... AR0026GFMASY \$48

BCMGunfighter - Large Latch ..... AR0026GFLASY \$48

## PRi Gas Buster Charging Handle

With the Military "Big Latch".

AR0026GBASY ..... \$90

## Badger Tactical Charging Handle Latch

AR0142 ..... \$23

Charging Handle with Badger Tac Latch  
AR0026TASY ..... \$48



## RRA Rear Sight Assemblies

See Page 50 for RRA LAR-8® Rear Sights

### RRA Stand Alone Rear Sight Assembly



Detachable with A2 rear sight ..... AR3305ASY \$110



### RRA Carry Handle Assembly

With A2 Rear Sight ..... AR0052CASY \$140

### RRA Match Carry Handle Assembly

A true 0 – 600 yard capable carry handle! Patent pending.

1/2min x 1/2min, .040 ..... AR0052CNMASY \$165

1/2min x 1/2min, .030 ..... AR0052CNMASY2 \$165

1/4min x 1/4min, .040 ..... AR0052CNMASY3 \$165

1/4min x 1/4min, .030 ..... AR0052CNMASY4 \$165

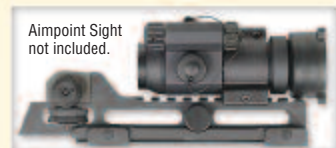

Aimpoint Sight not included.

### RRA Tactical Mount Assembly

With A2 Rear Sight ..... AR0125ASSY \$150



EOTech Sight not included.

### RRA Dominator2 EOTech Mount

Designed for FBI SWAT and HRT, the ideal EOTech mount, it places the dot just above the front sight post. With 7 slots for mounting flexibility. Incompatible with EOTech 553, 557 and other models with integral riser.

With A2 Rear Sight ..... AR0125FASSY \$150



## MI ERS Flip Rear Sight

Detachable flip-up rear sight with fully protected A2 style dual aperture, standard windage knob and locking detent. Hard coat anodized 6061 aluminum construction.

AR0169R ..... \$105



## A.R.M.S.® #40/40L Flip-Up Rear Sights

Spring loaded rear sights, for constant in battery action and repeat zero, held in the locked down position by a quick release lever, with 250-300 meter and 500-600 meter flip dual apertures.

A.R.M.S. #40 ..... AR3812 \$106

A.R.M.S. #40L Low Profile ..... AR3812L \$119

## RRA Match Front & Rear Sight Kit



With 1/4 min x 1/4 min or 1/2 min x 1/2 min MOA, and .030 or .040 hooded aperture, with .050 front sight post.

AR0070NMKIT ..... \$110

### Match .050 Front Sight Post

.050 ..... AR0009NM050 \$7.50

## RRA Flip Front Sight Gas Block Assembly

Flip Front Sight Gas Block with 3 sling swivels and tactical rail in the bayonet lug position.

AR3330ASY ..... \$85



## RRA Detachable Front Sight

For gas block height rail mounting.

AR0160 ..... \$40

## MI Flip-Up Front Sight

With smooth spring loaded ball bearing pivot and locking detent, hard coat anodized 6061 aluminum.

For Gas Block ..... AR0168R \$90

For Rail Handguard ..... AR0168RQ \$90

## Samson Quick Flip Folding Front Sight

Gas block mounting flip front sight, clears R4 handguards when folded, spring loaded deployment, hard coat anodized aluminum construction.

Samson FFS-EXT ..... AR0168S \$95



## Front & Rear Sight Sets



### A.R.M.S.® #71L Flip Front and Rear Sight Set

Both are made from durable, metal-reinforced polymer, with steel apertures. These standard-height flip-up sights are for mounting on same height rails (receiver and front rail at same height, not gas block height).

A.R.M.S. #71L - F/R  
Front and Rear Flip Sight Set . . . . . AR3830 \$89

## RRA Forged Lower Receivers

### RRA LAR-15® Lower Receiver



Mil-spec forged RRA LAR-15® stripped lower receiver.

Stripped . . . . . AR0114RRA \$140

Assembly of a lower receiver requires proper high quality parts and appropriate tools and experience. It should only be undertaken under those conditions/circumstances.

### Troy BattleSight Micro Front and Rear Sight Set



Rugged, durable front and rear sight set of shorter than standard flip sights made specifically for use on platforms with elevated rails, such as the RRA LAR-PDS™ Pistol and Carbine.

Troy BattleSight Micro  
Front & Rear Flip Sight Set . . . . . AR3368 \$199

### Dueck Defense RTS Rapid Transition Offset Sight Set



These offset front and rear sights provide the competitive, L/E or Military tactical shooter with the quickest transition possible from optical to offset iron sights, with a twist of the wrist. Made in the USA, machined from 7075 aluminum alloy bar stock, light weight and twice the strength of 6061 T6 aluminum. Picatinny rail mounted, same height above bore as standard sights. (Not compatible with forward charging handle on the RRA LAR-PDS. Not compatible with the RRA LAR-15LH LEF-T®)

Dueck Defense Rapid Transition  
RTS Sight Set . . . AR0168RTS \$238

### RRA LAR-15® Complete Lower Halves

#### With A2 Buttstock

Standard Trigger . . . . . AR0900B \$310

RRA Two Stage Trigger . . . . . AR0940B \$400

#### With RRA 6-Position Tactical CAR Stock

Standard Trigger . . . . . AR0901C \$325

RRA Two Stage Trigger . . . . . AR0990C \$415

### Pistol Receiver Extension Assembly

Includes pistol tube, CAR length buffer and action spring.

AR0113PASY . . . . . \$39

### Upper/Lower Receiver Sets

Forged A2 or forged A4 stripped upper receiver and forged RRA LAR-15® stripped lower receiver, each specially selected for an extra tight match rifle fit!

#### Match Receiver Set, stripped

With A2 Upper Receiver . . . . . AR0114A2SET \$380

With A4 Upper Receiver . . . . . AR0114A4SET \$380



SIGHT SETS / LAR-15® LOWERS



# Lower Parts



## Ambi-Catch

Drop-in ambidextrous mag release/catch.  
AR0099A . . . \$90

## Mag Catch Tool

Mag catch installation and maintenance tool.  
AR3597 . . . \$7

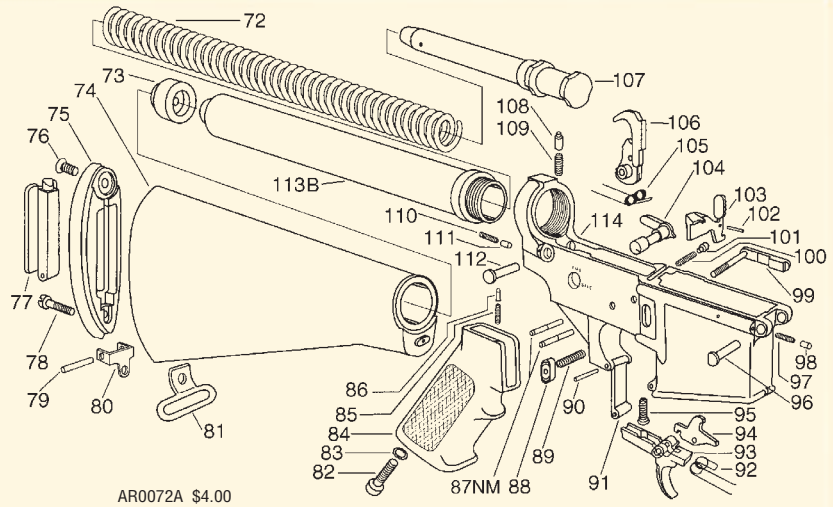

72A	Action spring, CAR	AR0072A	\$4.00
72B	Action spring, standard	AR0072B	\$4.00
73	Buttcap spacer	AR0073	\$1.50
74	Buttstock, black	AR0074	\$20.00
74G	Buttstock, green	AR0074G	\$20.00
75	Buttplate	AR0075	\$3.00
76	Buttplate screw	AR0076	\$3.00
77	Trap Door Assembly, plastic	AR0077PASY	\$5.00
78	Rear swivel screw	AR0078	\$1.00
79	Trap door hinge pin	AR0079	\$.75
80	Trap door hinge	AR0080	\$3.00
81	Rear sling swivel	AR0081	\$2.75
82	Pistol grip screw	AR0082	\$1.00
83	Lock washer	AR0083	\$.50
84	Pistol grip, black	AR0084	\$4.00
84G	Pistol grip, green	AR0084G	\$4.50
85	Safety detent spring	AR0085	\$.50
86	Safety detent	AR0086	\$.75
87NM	Hammer and trigger pin, NM (2 required)	AR0087NM	\$2.00
88	Magazine release button	AR0088	\$2.00
89	Magazine catch spring	AR0089	\$.50
90	Trigger guard pivot roll pin	AR0090	\$.50
91	Trigger guard	AR0091	\$5.00
92	Trigger spring	AR0092	\$1.00
93	Trigger, standard	AR0093	\$12.50
94	Disconnecter	AR0094	\$4.00
95	Disconnecter spring	AR0095	\$.50
96	Pivot pin	AR0096	\$3.50
97	Pivot pin spring	AR0097	\$.50

98	Pivot pin detent	AR0098	\$.50
99B	Magazine catch	AR0099B	\$5.00
100	Bolt catch spring	AR0100	\$.50
101	Bolt catch plunger	AR0101	\$.60
102	Bolt catch roll pin	AR0102	\$.50
103	Bolt catch	AR0103	\$7.50
104	Safety selector lever, standard	AR0104	\$9.00
104	Safety selector lever, Ambi	AR0104AMBI	\$25.00
104D	Safety selector lever, Star	AR0104D	\$9.00
105	Hammer spring	AR0105	\$1.00
106	Hammer with J pin, standard	AR0106	\$15.00
107A	Buffer assembly, CAR	AR0107A	\$11.00
107AH	Buffer assembly, CAR heavy	AR0107AH	\$23.00
107B	Buffer assembly, standard	AR0107B	\$13.00
108	Buffer retainer	AR0108	\$.70
109	Buffer retainer spring	AR0109	\$.50
110	Takedown pin spring	AR0110	\$.50
111	Takedown pin detent	AR0111	\$.50
112	Takedown pin	AR0112	\$3.50
113A	Receiver extension, CAR	AR0113A	\$18.00
113B	Receiver extension, standard	AR0113B	\$17.00
113T	Receiver extension, entry length	AR0113T	\$20.00
113P	Receiver extension, pistol length	AR0113P	\$25.00
114	<b>Lower Receiver</b>		See Page 69

**CAR Buttstock Lock Ring Nut** AR0172CB \$6.00  
**CAR Stock Receiver End Plate** AR0176CB \$5.00

Trigger group components shown in diagram are for single stage triggers only, the RRA Two Stage Match Trigger group is not available by its component parts.

## Star Safety Selector

Semi-auto . . . . . AR0104D \$9



## Ambi Star Safety Selector

Semi-auto . . . . . AR0104DA \$25

## Ambi Safety Selector

Semi-auto . . . . . AR0104AMBI \$25



U.S. Patent No. D627,415

## RRA Winter Trigger Guard

AR0091W . . . . . \$15



## Offset Pin

Adapts large hole lower receiver to small hole upper receiver . . . . . AR0192 \$4

## Offset Bushing

Adapts large hole upper receiver to small hole lower receiver . . . . . AR0191 \$3

## Lower Receiver Parts Kits



### LPK with Two Stage Trigger

Standard A2 Grip, Black	AR0120NM	\$180
Standard A2 Grip, Green	AR0120NMG	\$180
RRA Overmolded A2 Grip, Black	AR0120NMOM	\$195
Hogue Rubber Grip, Black	AR0120NMH	\$200
Hogue Rubber Grip, Green	AR0120NMHG	\$200
ERGO Grip, Right Hand, Black	AR0120NMER	\$200
ERGO Grip, Ambi, Black	AR0120NME	\$200
ERGO Grip, Ambi, Green	AR0120NMEG	\$200
ERGO Tactical Deluxe Grip, Black	AR0120NMET	\$235

### LPK with Two Stage Trigger & Star Safety

Standard A2 Grip, Black	AR0120NMS	\$180
-------------------------	-----------	-------



### LPK with Single Stage Trigger

Standard A2 Grip, Black	AR0120	\$70
Standard A2 Grip, Green	AR0120G	\$70
RRA Overmolded A2 Grip, Black	AR0120OM	\$85
Hogue Rubber Grip, Black	AR0120H	\$90
Hogue Rubber Grip, Green	AR0120HG	\$90
ERGO Grip, Right Hand, Black	AR0120ER	\$90
ERGO Grip, Ambi, Black	AR0120E	\$90
ERGO Grip, Ambi, Green	AR0120EG	\$90
ERGO Tactical Deluxe Grip, Black	AR0120ET	\$125

### With Single Stage Trigger & Star Safety

Standard A2 Grip, Black	AR0120S	\$70
-------------------------	---------	------

### LPK without Trigger Group

Standard A2 Grip, Black	AR0120LTG	\$55
-------------------------	-----------	------

## RRA Two Stage Match Trigger Kit

AR0093NMK	\$120
-----------	-------

## RRA Two Stage Match Chrome Trigger Kit

AR0093NMKC	\$155
------------	-------

## RRA Two Stage Varmint Trigger Kit

With 3.5-4 pounds pull weight	AR0093NMKV	\$120
-------------------------------	------------	-------

## RRA Two Stage Sporter Trigger Kit

To fit large pin lowers both with and without sear block.

AR0093NMKS	\$180
------------	-------



### RRA Single Stage Trigger Kit

Semi-auto	AR0093K	\$35
-----------	---------	------



### RRA LAR-15<sup>®</sup> Pin Kit

All of the pins you're likely to need to maintain your RRA LAR-15<sup>®</sup>.

RRA LAR-15 <sup>®</sup> Pin Kit	AR3252	\$10.50
---------------------------------	--------	---------

### RRA LAR-15<sup>®</sup> Spring Kit

Includes all the springs you're likely to need to maintain your RRA LAR-15<sup>®</sup>.



RRA LAR-15 <sup>®</sup> Spring Kit - CAR	AR3255A	\$20
RRA LAR-15 <sup>®</sup> Spring Kit - Rifle	AR3255B	\$20

### RRA LAR-15<sup>®</sup> "Oh Shoot" Kit

All the parts and pieces for your LAR-15<sup>®</sup> that you are most likely to wear out or lose at the worst possible time. Includes: 1 crush washer, 1 gas tube roll pin, 1 front sight detent and spring, 1 front sling swivel rivet, 1 charging handle latch roll pin, 2 firing pin retaining pins, 1 ejector, 1 ejector spring, 1 safety detent, 1 safety detent spring, 2 pivot pin springs, 2 pivot pin detents, 1 buffer retainer, 1 buffer retainer spring, 2 takedown pin springs, 2 takedown pin detents.

RRA LAR-15 <sup>®</sup> "Oh Shoot" Kit	AR3256	\$15
--	--------	------



High Impact Composite  
for Strength and Durability!

## RRA Tactical CAR Stock Kit

With Pivoting  
Steel Swivel

- Six-Position Collapsible** Complete with buffer and spring.
- Black, Commercial Receiver Extension . . . . . AR0250 **\$75**
  - Green, Commercial Receiver Extension . . . . . AR0250G **\$80**
  - Black, Mil-Spec Receiver Extension. . . . . AR0250MS **\$95**

- Fixed Position** AWB compliant, with buffer and spring.
- Black . . . . . AR0260 **\$65**
  - Green . . . . . AR0260G **\$70**

### Tactical CAR Stock Wrench



Engages the lock nut on the Tactical CAR stock . . . . . AR0165 **\$6**



### Tactical CAR Stock Rubber Buttpad

Some tools required for installation . . . AR0252 **\$15**



## Standard A2 Buttstock Kit

Includes buttstock with buttplate, sling loop, buffer, buffer tube, buffer spring, spacer and screw.

- Black . . . . . AR0074K **\$65**
  - Green . . . . . AR0074GK **\$70**
- Assembly only** Includes buttstock with buttplate and sling loop.
- Black. . . . . AR0074ASY **\$30**
  - Green. . . . . AR0074GASY **\$32.50**



### M&D DCM Rear Balance Wedge

3.5 pounds . . . RFLWTRR **\$25**

All applicable regulations/laws apply on the sale/shipment of products containing lead.



## RRA Entry Buttstock Kit

Complete with CAR buffer and spring.

- Black . . . . . AR0074TK **\$57.50**
- Green . . . . . AR0074TKG **\$60**



## RRA Delta CAR Stock Kit

New design six position collapsible stock with 1913 picatinny rail on the lower tube for sling mounts or other accessories. The lower tube also has a push-button release, o-ring sealed battery storage compartment. Stock Kit includes stock with buttpad, commercial receiver extension, end plate, lock nut, CAR buffer and spring.

- Black, Commercial Receiver Extension . . . . . AR0250D **\$130**



## RRA Operator CAR Stock Kit

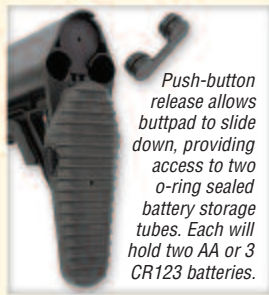

*Push-button  
release allows  
buttpad to slide  
down, providing  
access to two  
o-ring sealed  
battery storage  
tubes. Each will  
hold two AA or 3  
CR123 batteries.*

Six position collapsible stock featuring superior cheek weld, integral ribbed rubber buttpad, watertight battery storage and multiple sling mounts. Includes stock with buttpad, receiver extension, end plate, lock nut, CAR buffer and spring.

- Black, Commercial Receiver Extension . . . . . AR0250N **\$130**
- Green, Commercial Receiver Extension . . . . . AR0250NG **\$135**
- Tan, Commercial Receiver Extension . . . . . AR0250NT **\$135**
- Black, Mil-Spec Receiver Extension . . . . . AR0250NMS **\$150**

Please contact RRA Sales for current availability of specific colors.

**See Page 49 for RRA LAR-8® Stocks**





## RRA Operator A2 Stock Kit

The RRA Operator stock in a fixed A2 stock length, with superior cheek weld, integral ribbed rubber buttpad, watertight battery storage and multiple sling mounts. Includes stock with buttpad, standard receiver extension, buffer and spring.

- RRA Operator A2 Stock Kit, Black . . . . . AR0074NK **\$130**
- RRA Operator A2 Stock Kit, Green . . . . . AR0074NKG **\$140**
- RRA Operator A2 Stock Kit, Tan . . . . . AR0074NKT **\$140**



## ACE Skeleton Stocks

### ARFX Full Skeleton Stock

Slips over standard length receiver extension (AR0113B, not included). With sling swivel, rubber buttpad. . . . . AR3100 **\$97.50**

### ARFXE Shorty Skeleton Stock

Slips over entry length receiver extension (AR0113T, not included). With sling swivel, rubber buttpad. . . . . AR3105 **\$97.50**



## Magpul PRS Stock

Drop in replacement A1/A2 stock body. Adjustable for height and length of pull. At it's shortest length of pull it is about the length of an A1 stock and extends about a half inch longer than an A2 stock. Mounts on standard A1/A2 buffer tube/receiver extension. Incompatible with RRA LAR-8 due to charging handle clearance.

- Magpul PRS Stock, Black . . . . . AR0074MB **\$255**
- Magpul PRS Stock, Green . . . . . AR0074MG **\$255**

## RRA Overmolded A2 Pistol Grip

Same size and shape as the A2 grip, but overmolded with rubber for enhanced grip and comfort. Note: Not CMP approved for Service Rifle competition.

- Black . . . . . AR00840M **\$20**



## A2 Pistol Grip

- Black . . . . . AR0084 **\$4**
- Green . . . . . AR0084G **\$4.50**



## Hogue Rubber Pistol Grip

- Black . . . . . AR0084H **\$22**
- OD Green . . . . . AR0084HG **\$24**
- Desert Tan. . . . . AR0084HT **\$24**



## ERGO SureGrip

- Right Hand - Black . . . . . AR0084ER **\$22**
- Ambi - Black . . . . . AR0084E **\$22**
- Ambi - Green . . . . . AR0084EG **\$24**



## ERGO Tactical Deluxe Pistol Grip

Ambidextrous design, with adjustable palm shelf and ERGO's SureGrip no-slip surface.

- Black . . . . . AR0084ET **\$60**

## CAR Stock Receiver End Plate

- AR0176CB . . . . . \$5
- With Dual Loop . . . . .
- AR0144C . . . . . \$14



## A2 Stock Receiver End Plate

With single sling loop on left side for right hand shooters. (Will not work with RRA Operator A2 Stock) . . . . . AR0144A **\$32.50**

## MI End Plate Sling Adapters

- Install without removing extension.
- Slotted . . . . . AR3625 **\$36**
- Loop . . . . . AR3626 **\$36**



## MI Heavy Duty Quick Detach

- MCTAR-30HD . . . . . AR3630 **\$60**



## MI Quick Detach Rear Sling Adapter

- For Tactical CAR Stock . . . . . AR3624 **\$40**



BUTTSTOCKS / PISTOL GRIPS



## A2 Handguards

- Black ..... AR0010B \$19
- Green ..... AR0010BG \$19.50

### Match Free Float Barrel Sleeve Kit



- AR0127 ..... \$100
- with Thermo Mold Handguards ..... AR0129 \$130
- with Injection Molded Handguards ..... AR0128 \$115

### M&D DCM A2 Handguard Weight



- 3.6 pounds ..... RFLEWTFRT \$35

All applicable regulations/laws apply on the sale/shipment of products containing lead.



## Mid-Length Handguards

- Black ..... AR0010C \$19
- Green ..... AR0010CG \$19.50

## R-4 Handguards

- Black, with double heat shields ..... AR0010ASHS \$26
- Green ..... AR0010ASHSG \$21

## CAR Handguards

- Black ..... AR0010A \$19
- Green ..... AR0010AG \$19.50



## RRA Aluminum Free Float Tubes

- Rifle Length ..... AR0010BAH \$75
- Mid-Length ..... AR0010CAH \$70
- CAR Length ..... AR0010AAH \$65
- Pistol Length ..... AR0010PAH \$55

NOTE: RRA Free Float Tubes and Free Float Rail Handguards may require some gunsmithing for installation.

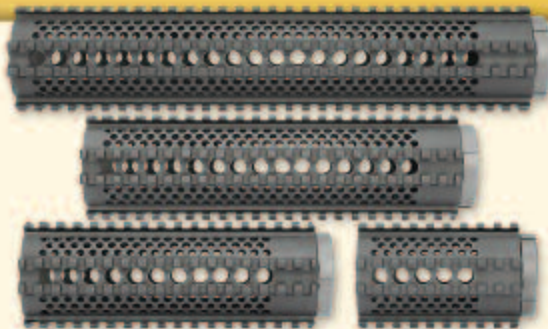

## RRA Quad Rail Aluminum Free Float Handguards

Lightweight design, hardcoat anodized to mil-spec.

Each includes three Ladder Rail Covers, seven slot.

- Rifle Length ..... AR0010G \$175
- Mid-Length ..... AR0010H \$145
- CAR Length ..... AR0010F \$135
- Pistol Length ..... AR0010P \$120



## RRA Half Quad Aluminum Free Float with Full Length Top Rail

Each includes three Ladder Rail Covers, seven slot. for Mid-Length gas system ..... AR0010HQF \$155

Half Quad Handguard style may vary from picture.



## RRA Advanced Half Quad Aluminum Free Float with Full Length Top Rail

Each includes three Ladder Rail Covers, seven slot. for Rifle Length gas system ..... AR0010GA \$180 for Mid-Length gas system ..... AR0010HA \$170

Advanced Half Quad Handguard style may vary from picture.

See Page 49 for RRA LAR-8® Quad Rails



**NEW!**

## RRA TRO Free Float Rails

### TRO - Top Rail Octagonal

RRA TRO Handguards require the use of a low profile gas block.

- TRO-Std - Rifle Length ..... AR0010TRB **\$135**
- TRO-Mid - Mid-Length ..... AR0010TRC **\$125**
- TRO-CAR - CAR Length ..... AR0010TRA **\$115**



### New RRA TRO-XL - 15 Inch Extended Length Rail

- TRO-XL - Extended Length ..... AR0010TRXL **\$150**

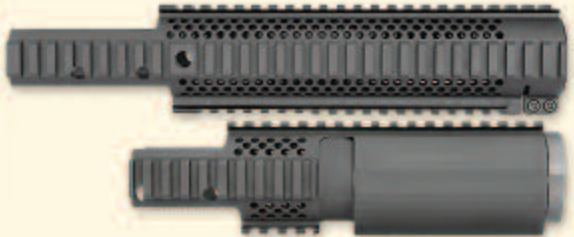

## RRA Wraparound Quad Rails

Aluminum free float quad rail handguards with extended rails on each side that wraparound the front sight base.

Each includes three Ladder Rail Covers, seven slot.

### Mid-Length Wraparound Quad

- For mid-length gas system ..... AR0010HQM **\$180**

### CAR Wraparound Half Quad

- For CAR length gas system ..... AR0010HQC **\$145**

## Picatinny Rail Covers



- Solid Rail Covers, Five Slot, Black ..... AR3040 **\$4**
- Solid Rail Covers, Ten Slot, Black ..... AR3041 **\$8**
- Solid Rail Covers, Fifteen Slot, Black ..... AR3042 **\$12**
- Ladder Rail Cover, Seven Slot, Black ..... AR3043 **\$4**
- Ladder Rail Cover, Eighteen Slot, Black ..... AR3044 **\$12**
- Ladder Rail Cover, Eighteen Slot, Green ..... AR3044G **\$12**

**NEW!**

## RRA Delta Quad Rail Aluminum Two Piece Drop-In Handguards

Aluminum two piece drop-in (non-free float) quad rail handguards.

- Mid-Length ..... AR0010DH **\$130**
- CAR Length ..... AR0010DF **\$130**

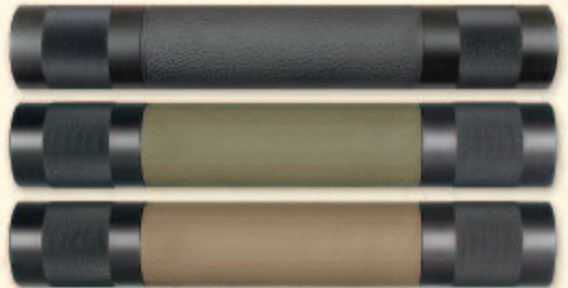

## Hogue Overmolded Free Float Tubes

Aluminum free float tube, overmolded with soft rubber.

- Rifle Length, Black ..... AR0010BHH **\$120**
- Rifle Length, OD Green ..... AR0010BHGG **\$120**
- Rifle Length, Desert Tan ..... AR0010BHHT **\$120**
- CAR Length, Black ..... AR0010AHH **\$95**
- CAR Length, OD Green ..... AR0010AHHG **\$95**
- CAR Length, Desert Tan ..... AR0010AHHHT **\$95**

## Troy Modular Combat Grip



Three part modular design, converts easily into two sizes, 4 5/8 inches tall when fully assembled, 3 1/4 inches tall in short mode. With high capacity internal storage.

- AR3220 ..... **\$69**

## Graphite Vertical Foregrip

Attaches to picatinny rails, easy on/off.

- Black ..... AR3225 **\$42**
- Green ..... AR3225G **\$43.50**



HANDGUARDS AND RELATED



# RRA LAR-15® Mags

## .223/5.56mm



10, 20 and 30 round magazines for LAR-15® and other .223/5.56 AR platform firearms.

- 10 Round Aluminum Mag . . . . . AR0116 \$22
- 20 Round Aluminum Mag . . . . . AR0116LE20RD \$22
- 30 Round Aluminum Mag . . . . . AR0116LE30RD \$22
- 30 Round Polymer Mag . . . . . AR0116N30 \$22

## AR .223 Mag Coupler



Couples two .223 caliber AR magazines together, lightweight fiberglass construction. For use with aluminum bodied GI mags only.

- AR3062 . . . . . \$15

## Thermold .223/5.56mm 5, 10 & 20 Round Mags



Black Zytel nylon mags for AR .223/5.56mm caliber.

- 5 Round . . . . . AR0116T05 \$20
- 10 Round . . . . . AR0116T10 \$20
- 20 Round . . . . . AR0116T20 \$20

## Thermold .223/5.56 30/45 Round Dual Capacity Mag

Black Zytel nylon mag for AR .223/5.56mm caliber, dual capacity mag stores 30 rounds compressed, opened up will store 30 rounds with tension off the spring, or up to 45 rounds fully loaded.

### Thermold 30/45 Dual Capacity Magazine

- AR0116T30/45 . . . . . \$25

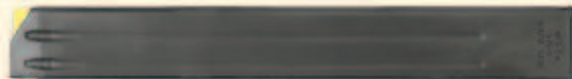

## .40 S&W RRA LAR-40® 30 Round Magazine

**NEW!**

New design steel .40 S&W mags . . . . . 4S0116 \$55



## 9mm RRA LAR-9® 32 Round Mag

New and Improved . . . . . 9MM0116A \$35

## 9mm RRA LAR-9® 10 Round Mag

9MM0116LC . . . . . \$45

## 9mm UZI 25 Round Magazine

Modified for conversion use . . . . . 9MM0116 \$35

## PRi 6.8mm SPC Steel Magazines



Steel magazines with guided blue followers.

- 5 Round . . . . . SPC0116C05 \$43
- 10 Round . . . . . SPC0116C10 \$43
- 15 Round . . . . . SPC0116C15 \$43
- 25 Round . . . . . SPC0116C \$43

## RRA LAR-8® .308 Caliber Polymer Mags



20 Round Poly RRA LAR-8® Mag  
308A0116T20 . . . . . \$25



10 Round Poly RRA LAR-8® Mag  
308A0116T10 . . . . . \$35

5 Round Poly RRA LAR-8® Mag  
308A0116T05 . . . . . \$35

3 Round Poly RRA LAR-8® Mag  
308A0116T03 . . . . . \$35

**NOTE:** These are inch-pattern based LAR-8 magazines. No guarantee is made of their compatibility with any rifle other than the LAR-8. Due to the progressive improvements to the design of the LAR-8 magwell, some magazines may not drop freely from all LAR-8s and/or may require filing of the spacing tab.

ACCESSORIES

# LULA Mag Loaders

## .223 Caliber AR LULA Mag Loader

Easy loading and unloading, works with RRA LAR-15® and 6.8 SPC magazines.

AR0119 ..... \$30

## 9mm Colt SMG Style LULA Mag Loader

Works with RRA LAR-9® magazines.

9MM0119 ..... \$32.50

## .308 LAR-8 and FAL LULA Mag Loader

Works with RRA LAR-8® mags and FAL inch and metric mags.

308A0119 ..... \$31



## Dewey Breach Rod Guide

With o-ring seal to prevent oil, solvent and debris from entering the action. Constructed of anodized aluminum and delrin.

AR Style .223 Caliber ..... AR3590 \$22

AR Style .308 Caliber ..... 308A3590 \$25

AR Style 6.8 SPC Caliber ..... SPC3590 \$27



## Dewey AR-Link Cleaning Pin

Utilizes rear take down pin to hold upper and lower receiver open in place for cleaning. Fits all AR style rifles, regardless of caliber, with standard and oversize take down pins up to .316 inches in diameter. .... AR3591 \$15

## IOSSO Brush Kits

Reusable blue Nyflex fiber brushes, retain their shape even with repeated use, fitted for precision cleaning. Includes upper receiver brush, chamber brush, bolt carrier brush and bore brush.



IOSSO AR-15 Brush Kit  
AR3595 ..... \$17.75

IOSSO LAR-8 Brush Kit  
308A3595 ..... \$17.75

## .223 Barrel Nut Wrench Head

AR0162 ..... \$65



## Rock River Arms Cleaning Station

Solid oak rifle stand, perfect for cleaning and other gunsmithing uses.

For RRA LAR-15 size magwell ..... AR0150 \$50

For RRA LAR-8 size magwell ..... 308A0150 \$50

## Pro-Shot Tactical Cleaning Kits

The next generation of compact cleaning kits, well equipped with brushes, patches, jag and more, with black Cordura pouch with MOLLE mounting system.



Tactical Cleaning Kit with  
Stainless Steel Cleaning Rod  
.223 Caliber Rod Kit

AR3580 ..... \$59.50

.308 Caliber Rod Kit  
308A3580 ..... \$60

Tactical Cleaning Kit with  
Pull-Through Cleaning Cable  
.223 Caliber Pull-Through Kit

AR3585 ..... \$36.50

.308 Caliber Pull-Through Kit  
308A3585 ..... \$37

## Dewey Complete Cleaning Kits



Complete kit with nylon coated cable, 1/2 oz cleaner/lubricant, brushes, rods, patches, case remover, Cordura pouch and more. For 20 inch and shorter barrels.

Dewey Cleaning Kit for .223 Cal.  
AR3592 ..... \$40

Dewey Cleaning Kit for .308 Cal.  
308A3592 ..... \$42



## .223 Caliber Cleaning Kit

.223 caliber cleaning kit with pouch, for 20 inch and shorter barrels.  
AR3600 ..... \$30

ACCESSORIES



## Rock River Arms Discreet Case

A high quality case for protecting and transporting your rifle or carbine. Made of black Cordura with heavy duty YKK zippers, eight external D-rings, foam padding and adjustable detachable shoulder strap. Features a large internal zippered pocket, three removable velcro closed magazine pouches, a protective padded divider and four adjustable velcro weapon keepers. Quality design and construction, with embroidered RRA logo.

- RRA Discreet Rifle Case**  
42 inch x 11 inch x 5.5 inch . . . . . AR3480 **\$165**
- RRA Discreet CAR Case**  
36 inch x 11 inch x 5.5 inch . . . . . AR3475 **\$165**

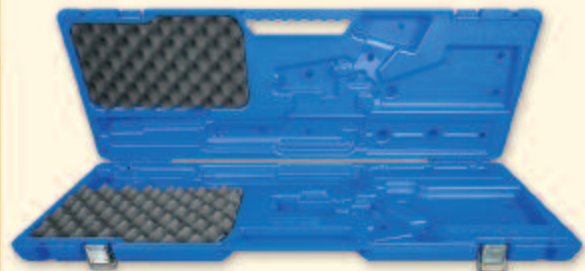

## Rock River Arms Safe Case

Lockable hard plastic case, provides safe, secure storage and transport of your broken down rifle or carbine. The same case that ships with many RRA rifles of 18" barrel length or longer . . . . . ARCASE **\$34**



## Rock River Arms Carbine Case

Hard plastic shell with thick foam interior, provides safe, secure storage of your fully assembled carbine. The same case that ships with many RRA carbines of 16 inch barrel length. . . . . ARCASE4 **\$40**

## RRA Hi-Rise Scope Mount



- With integral rings.
- With 1 inch rings. . . . . AR0130 **\$50**
- With 30mm rings. . . . . AR0131 **\$50**
- Left Hand Model - with 1 inch rings . . . . . LH0130 **\$50**
- Left Hand Model - with 30mm rings . . . . . LH0131 **\$50**

## RRA Hi-Rise Cantilever Scope Mount

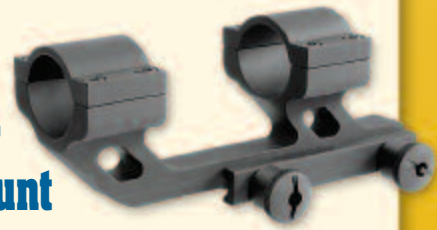

- With integral rings.
- With 1 inch rings . . . . . AR0130T **\$60**
- With 30mm rings . . . . . AR0131T **\$60**

## RRA Flattop Riser Base



- AR0136ASY . . . . . **\$55**

## RRA Scout Rail

- AR0134 . . . . . **\$72.50**

## U.S. Tactical Systems A2 Handle Mount



- AR0124 . . . . . **\$24**

## Midwest Industries A2 Adjustable Cantilever Mount



- Heavy duty and lightweight hard coat anodized 6061 aluminum with MIL-STD 1913 rail, allows most optics to co-witness with iron sights.
- AR3629. . . . . **\$117**



# EOTech HWS

EOTech 553



Holographic Weapon Sights by L3, instantly visible in any light, for true two eyes open shooting, with 20 brightness settings. Battle proven to withstand the abuse that any harsh environment, high powered weapon platform, or military mission can dish out.

**EOTech 512** The most popular model, perfect for those that want the best without the need for night vision compatibility.

**Uses two "AA" Batteries** . . . . . AR3781 **\$459**

**EOTech 552 - Night Vision Compatible Model**

**Uses two "AA" Batteries** . . . . . AR3783 **\$569**

**EOTech 553 - with Dual A.R.M.S. Throw Levers**

Pictured above, mounts directly to A4 upper and when so mounted places dot/ring at same height as other EOTechs on the Dominator2.

**Uses two Lithium Batteries.** . . . . . AR3784 **\$749**



# EOTech XPS2-0

The shortest and lightest EOTech yet, runs on a single 123 battery, requires at most 2 3/4 inches of rail space, leaving more room for iron sights or NV mount.

**AR3788** . . . . . **\$539**

# New Improved EOTech G33.STS Magnifier

Shorter and lighter than the G23, with new quick Switch to Side (STS) mount for faster transitions from 3x to 1x, larger field of view, adjustable diopter for improved, more precise focusing. Also has locking, quick detach lever for easy attachment/removal of optic and mount.

Magnifier aligns perfectly with standard height sights and comes with a 7mm riser to accommodate the 7mm raised sights.

**EOTech G33.STS Magnifier** . . . . . AR3787 **\$589**



# Rock River Arms 3-Point Sling

Fully adjustable 3-point sling with quality black nylon webbing and quick release buckle.

**RRA Sling** . . . . . AR0137R **\$25**



# Turner Saddlery All Weather Synthetic Service Rifle Sling

All Weather Synthetic sling, CMP approved, 54"/56" adjustable with mil-spec parkerized steel hardware and copper rivets.

**Turner AWS Sling - Black** . . . . . AR0139B **\$65**

**Turner AWS Sling - Green** . . . . . AR0139G **\$65**



# CMP Nylon Sling

Adjustable black nylon sling.

**AR0138** . . . . . **\$14**



# Patrol Incident Gear PIG Drop-Slider Mk-2 Sling

This unique single-point design, positions the slung weapon to the side, NOT in your way. Comes with three "Pigtail" mounting adapters: HK Hook, QD Swivel, and Web, for max flexibility in weapon mounting and secondary release. Quality materials and construction, bungee for shock absorption, fully adjustable for comfort and fast transitions.

**PIG Drop-Slider Mk-2 Sling** . . . . . AR0137P **\$75**



# MAMBA Combat Sling

The first sling designed for full contact engagement with unique stretch "Power Strike Zone". Works for right or left hand shooters, with quick release buckles, customizable positioning and fast and easy transitions.

**For A2 Buttstock** . . . . . AR0137MA **\$40**

**For CAR/Tactical CAR Stock.** . . . . . AR0137MC **\$40**

# Viking Tactics VTAC Quick Adjust Sling

Designed for the tactical shooter, quickly adjusts to several different shooting positions and for carry slung tightly across the back, great for climbing, running.

**VTAC Sling** . . . . . AR0137VTAC **\$36**



# MI Rail Mount Front Sling Adapters

## Front Sling Adapter

Rail mount, with Swivel Stud

**AR3621** . . . **\$24**



## Front Sling Adapter

Rail Mount, with Loop

Patent US D508,726S

**AR3619** . . . **\$40**



## Front Sling Adapter

Rail mount with Sling Swivel

**AR3620** . . . **\$34**



## Quick Detach Front Sling Adapter

Rail mount with QD Sling Swivel

**AR3622** . . . **\$34**



ACCESSORIES



## RRA Logo T-Shirts

- Solid Color Short Sleeve** - Colors vary
- Small, Medium, Large, X-Large ..... CL0201 **\$10**
  - XX-Large, XXX-Large ..... CL0201 **\$12**
- Solid Color Long Sleeve** - Colors vary
- Small, Medium, Large, X-Large ..... CL0401 **\$16**
  - XX-Large, XXX-Large ..... CL0401 **\$18**
- Camo Short Sleeve T-Shirts** - Green Camo, Urban Camo
- Small, Medium, Large, X-Large ..... CL0204 **\$19**
  - XX-Large ..... CL0204 **\$21**



## RRA Logo Women's T-Shirts

- Women's Short Sleeve T-Shirts** - Colors vary
- Small, Medium, Large, X-Large ..... CL0210 **\$12**
  - XX-Large ..... CL0210 **\$14**

## RRA Logo Shooter Tank Tops



- Sleeveless T-shirts, colors vary.
- Medium, Large, X-Large  
CL0303 . . . **\$11**
  - XX-Large, XXX-Large  
CL0304 . . . **\$13**



## RRA Logo Junior Women's Fitted T-Shirts

- Junior's Fitted Short Sleeve T-Shirts** - Colors vary
- Medium, Large, X-Large ..... CL0212 **\$13**
  - XX-Large ..... CL0212 **\$15**



## RRA Logo Tank Tops

- Colors vary.
- Medium, Large, X-Large  
CL0301 ..... **\$10**
  - XX-Large  
CL0302 ..... **\$12**

**Please visit [www.rockriverarms.com](http://www.rockriverarms.com) for the best selection of RRA Logo clothing in the latest styles & colors.**





## RRA Logo Hooded Sweatshirts

**Camouflage** - Green Camo, Urban Camo  
 Small, Medium, Large, X-Large . . . . . CL0206 **\$35**  
 XX-Large . . . . . CL0206 **\$38**

**Solid Color** - Colors vary  
 Small, Medium, Large, X-Large . . . . . CL0102 **\$30**  
 XX-Large, XXX-Large . . . . . CL0102 **\$36**



## RRA Logo Women's Hooded Sweatshirts

- Colors vary  
 Small, Medium, Large, X-Large . . . . . CL0215 **\$30**  
 XX-Large, XXX-Large . . . . . CL0215 **\$36**



## RRA Logo Sweatshirts

- Colors vary  
 Small, Medium, Large, X-Large . . . . . CL0101 **\$22**  
 XX-Large, XXX-Large . . . . . CL0101 **\$25**



## RRA Logo Caps

High quality caps with embroidered Rock River Arms logo.  
 Colors vary . . . . . CL0903 **\$10**  
**RRA Ladies Pink Logo Cap** . . . . . CL0905 **\$12**



## RRA Specialty Caps

Available in four styles: Brown and Stone Two-Tone / Orange with Camo Patch / Urban Camo with 3D Embroidery / Advantage Max-4 HD Camo . . . . . CL0900 **\$12**



## RRA Logo Coolie Bottle Insulators

Colors vary . . . . . RRACOLIE2 **\$4.50**



## RRA Logo Coolie Can Insulators

Colors vary . . . . . RRACOLIE **\$2.50**

RRA LOGO GEAR



CAR Length Gas System

## RRA LAR-15® LE CAR A2

CAR A2  
LE1010

RRA  
Tactical  
CAR Stock

### STANDARD CONFIGURATION

CALIBER	5.56mm NATO Chamber for 5.56mm & .223 Cal.
LOWER / UPPER RECEIVER	Forged RRA LAR-15® / Forged A2 Upper
BARREL	Chrome Lined 16 Inch Lightweight, 1:9 Twist
MUZZLE DEVICE	A2 Flash Hider / 1/2-28 Thread
TRIGGER	Standard Single Stage
HANDGUARD	CAR Handguard
BUTTSTOCK / GRIP	RRA 6-Position Tactical CAR Stock / A2 Grip
WEIGHT / LENGTH / ACCURACY	7.5 lbs / 35.25" / 1.5 MOA at 100 Yds
INCLUDED	One Mag, Case, Sling, Manual, Warranty

- RRA LAR-15® LE CAR A2 .223/5.56mm . . . LE1010
- RRA LAR-15® LE CAR A2 SBR Model . . . . . LE2010
- RRA LAR-15® LE CAR A2 Select Fire Model . . . . . LE9010

**RRA LAR-6.8® LE CAR A2** 6.8 Rem SPC . . LE1110

Contact your RRA LE/Gov't Representative for LE Pricing  
OPTIONS AND UPGRADES LISTING ON PAGES 10 & 11

CAR Length Gas System

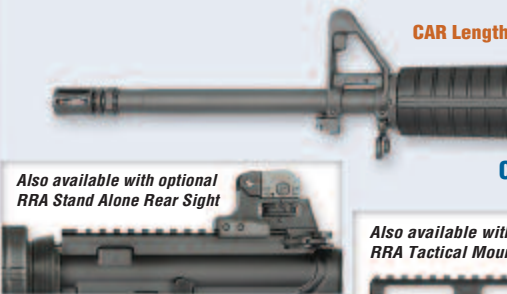

CAR A4 LE1020

Comes standard with  
Detachable A2 Carry Handle

Also available with optional  
RRA Stand Alone Rear Sight

Also available with optional  
RRA Tactical Mount

RRA  
Tactical  
CAR Stock

## RRA LAR-15® LE CAR A4

**RRA LAR-15® LE CAR A4** .223/5.56mm

With Detachable A2 Carry Handle . . . . . LE1020

RRA LAR-15® LE CAR A4 SBR Model . . . . . LE2020

RRA LAR-15® LE CAR A4 Select Fire Model . . . . . LE9020

**RRA LAR-6.8® LE CAR A4** 6.8 Rem SPC

With Detachable A2 Carry Handle . . . . . LE1120

Contact your RRA LE/Gov't Representative for LE Pricing

OPTIONS AND UPGRADES LISTING ON PAGES 10 & 11

### STANDARD CONFIGURATION

CALIBER	5.56mm NATO Chamber for 5.56mm & .223 Cal.
LOWER / UPPER RECEIVER	Forged RRA LAR-15® / Forged A4 Upper
BARREL	Chrome Lined 16 Inch Lightweight, 1:9 Twist
MUZZLE DEVICE	A2 Flash Hider / 1/2-28 Thread
TRIGGER	Standard Single Stage
HANDGUARD	CAR Handguard
BUTTSTOCK / GRIP	RRA 6-Position Tactical CAR Stock / A2 Grip
WEIGHT / LENGTH / ACCURACY	7.5 lbs / 35.25" / 1.5 MOA at 100 Yds
INCLUDED	One Mag, Case, Sling, Manual, Warranty

Also available with optional  
RRA Dominator2 Mount



## RRA Law Enforcement & Government Sales

RRA LE Models are available only to Law Enforcement and Government Agencies and authorized individual officers. For further information and pricing, please contact the RRA LE/Government Sales Office at **1-866-980-7625**, or your RRA LE/Government Sales Representative or RRA LE/Government Dealer. Complete RRA LE/Government contact information is available at [www.rockriverarms.com/LE](http://www.rockriverarms.com/LE).



Mid-Length Gas System

Mid-Length A2 LE1030

RRA  
Tactical  
CAR Stock

### STANDARD CONFIGURATION

CALIBER	5.56mm NATO Chamber for 5.56mm & .223 Cal.
LOWER RECEIVER	Forged RRA LAR-15® Lower Receiver
UPPER RECEIVER	Forged A2 Upper Receiver
BARREL	Chrome Lined 16 Inch Lightweight, 1:9 Twist
MUZZLE DEVICE	A2 Flash Hider / 1/2-28 Thread
TRIGGER	Standard Single Stage
HANDGUARD	Mid-Length Handguard
BUTTSTOCK	RRA 6-Position Tactical CAR Stock
PISTOL GRIP	A2 Grip Pistol Grip
WEIGHT / LENGTH	7.5 pounds / 35.25 inches
ACCURACY	1.5 MOA at 100 yards
INCLUDED	One Mag, Case, Sling, Manual, Warranty

OPTIONS AND UPGRADES LISTING ON PAGES 10 & 11

## RRA LAR-15® LE Mid-Length A2

RRA LAR-15® LE Mid-Length A2  
.223/5.56mm ..... LE1030

RRA LAR-6.8® LE Mid-Length A2  
6.8 Rem SPC ..... LE1130

Contact your RRA LE/Gov't Representative for LE Pricing



Mid-Length Gas System

Mid-Length A4 LE1040

Comes standard with  
Detachable A2 Carry Handle

RRA  
Tactical  
CAR Stock

Also available with optional  
RRA Stand Alone Rear Sight

Also available with optional  
RRA Tactical Mount

Also available with optional  
RRA Dominator2 Mount

## RRA LAR-15® LE Mid-Length A4

RRA LAR-15® LE Mid-Length A4  
.223/5.56mm - with Detachable A2 Carry Handle ..... LE1040

RRA LAR-6.8® LE Mid-Length A4  
6.8 Rem SPC - with Detachable A2 Carry Handle ..... LE1140

Contact your RRA LE/Gov't Representative for LE Pricing

OPTIONS AND UPGRADES LISTING ON PAGES 10 & 11

### STANDARD CONFIGURATION

CALIBER	5.56mm NATO Chamber for 5.56mm & .223 Cal.
LOWER RECEIVER	Forged RRA LAR-15® Lower Receiver
UPPER RECEIVER	Forged A4 Upper Receiver
BARREL	Chrome Lined 16 Inch Lightweight, 1:9 Twist
MUZZLE DEVICE	A2 Flash Hider / 1/2-28 Thread
TRIGGER	Standard Single Stage
HANDGUARD	Mid-Length Handguard
BUTTSTOCK	RRA 6-Position Tactical CAR Stock
PISTOL GRIP	A2 Grip Pistol Grip
WEIGHT / LENGTH	7.5 pounds / 35.25 inches
ACCURACY	1.5 MOA at 100 yards
INCLUDED	One Mag, Case, Sling, Manual, Warranty





## RRA LAR-15® LE CAR UTE2

### STANDARD CONFIGURATION

CALIBER	5.56mm NATO Chamber for 5.56mm & .223 Cal.
LOWER RECEIVER	Forged RRA LAR-15®
UPPER RECEIVER	Forged UTE2 - Universal Tactical Entry
BARREL	Chrome Lined 16 Inch Lightweight, 1:9 Twist
MUZZLE DEVICE	A2 Flash Hider / 1/2-28 Thread
TRIGGER	Standard Single Stage
HANDGUARD	CAR Handguard
BUTTSTOCK / GRIP	RRA 6-Position Tactical CAR Stock / A2 Grip
WEIGHT / LENGTH / ACCURACY	7.5 lbs / 35.25" / 1.5 MOA at 100 Yds
INCLUDED	One Mag, Case, Sling, Manual, Warranty

- RRA LAR-15® LE CAR UTE2**  
.223/5.56mm ..... LE1050
  - RRA LAR-15® LE CAR UTE2 SBR Model** ..... LE2050
  - RRA LAR-15® LE CAR UTE2 Select Fire Model** .. LE9050
  - RRA LAR-6.8® LE CAR UTE2**  
6.8mm Rem SPC ..... LE1150
- Contact your RRA LE/Gov't Representative for LE Pricing*  
**OPTIONS AND UPGRADES LISTING ON PAGES 10 & 11**



## RRA LAR-15® LE Mid-Length UTE2

### STANDARD CONFIGURATION

CALIBER	5.56mm NATO Chamber for 5.56mm & .223 Cal.
LOWER RECEIVER	Forged RRA LAR-15®
UPPER RECEIVER	Forged UTE2 - Universal Tactical Entry
BARREL	Chrome Lined 16 Inch Lightweight, 1:9 Twist
MUZZLE DEVICE	A2 Flash Hider / 1/2-28 Thread
TRIGGER	Standard Single Stage
HANDGUARD	Mid-Length Handguard
BUTTSTOCK / GRIP	RRA 6-Position Tactical CAR Stock / A2 Grip
WEIGHT / LENGTH / ACCURACY	7.5 lbs / 35.25" / 1.5 MOA at 100 Yds
INCLUDED	One Mag, Case, Sling, Manual, Warranty

- RRA LAR-15® LE Mid-Length UTE2**  
.223/5.56mm ..... LE1060
  - RRA LAR-6.8® LE Mid-Length UTE2**  
6.8mm Rem SPC ..... LE1160
- Contact your RRA LE/Gov't Representative for LE Pricing*  
**OPTIONS AND UPGRADES LISTING ON PAGES 10 & 11**



## RRA Law Enforcement & Government Sales

RRA LE Models are available only to Law Enforcement and Government Agencies and authorized individual officers. For further information and pricing, please contact the RRA LE/Government Sales Office at **1-866-980-7625**, or your RRA LE/Government Sales Representative or RRA LE/Government Dealer. Complete RRA LE/Government contact information is available at [www.rockriverarms.com/LE](http://www.rockriverarms.com/LE).



**Chrome Lined Lightweight  
R-4 Profile Barrel**

**Comes standard with  
Detachable A2 Carry Handle**

*Also available with optional  
RRA Stand Alone Rear Sight*

**Side Mount Sling Swivel**

*Also available with optional  
RRA Tactical Mount*

**RRA  
Tactical  
CAR Stock**

*Also available with optional  
RRA Dominator2 Mount*

## STANDARD CONFIGURATION

CALIBER	5.56mm NATO Chamber for 5.56mm & .223 Cal.
LOWER / UPPER RECEIVER	Forged RRA LAR-15® / Forged A4 Upper
BARREL	Chrome Lined 16 Inch R-4 Lightweight, 1:9 Twist
MUZZLE DEVICE	A2 Flash Hider / 1/2-28 Thread
TRIGGER	Standard Single Stage
HANDGUARD	R-4 Handguard
BUTTSTOCK / GRIP	RRA 6-Position Tactical CAR Stock / A2 Grip
WEIGHT / LENGTH / ACCURACY	7.5 lbs / 35.25" / 1.5 MOA at 100 Yds
INCLUDED	One Mag, Side Sling Swivel, Case, Sling, Manual, Warranty

**OPTIONS AND UPGRADES LISTING ON PAGES 10 & 11**

# RRA LAR-15® LE R-4 Carbine

**RRA LAR-15® LE R-4 Carbine .223/5.56mm**  
With Detachable A2 Carry Handle ..... LE1070

**RRA LAR-15® LE R-4 Carbine SBR Model** ..... LE2070

**RRA LAR-15® LE R-4 Carbine Select Fire Model** ..... LE9070

*Contact your RRA LE/Gov't Representative for LE Pricing*

**RRA Flip Front Sight  
Gas Block Assembly**

**A.R.M.S. #40 Flip-Up Rear Sight**

**RRA Quad Rail Aluminum  
Free Float - CAR Length**

**RRA  
Tactical  
CAR Stock**

## STANDARD CONFIGURATION

CALIBER	5.56mm NATO Chamber for 5.56mm & .223 Cal.
LOWER RECEIVER	Forged RRA LAR-15® Lower Receiver
UPPER RECEIVER	Forged A4 Upper Receiver
BARREL	Chrome Lined 16 Inch Lightweight, 1:9 Twist
MUZZLE DEVICE	A2 Flash Hider / 1/2-28 Thread
FRONT SIGHT	RRA Flip Front Sight Gas Block Assembly
REAR SIGHT	A.R.M.S. #40 Flip-Up Rear Sight
TRIGGER	Standard Single Stage
HANDGUARD	RRA Quad Rail Aluminum Free Float, CAR Length
BUTTSTOCK / GRIP	RRA 6-Position Tactical CAR Stock / A2 Grip
WEIGHT / LENGTH	6.8 pounds / 35.25 inches
ACCURACY	1.5 MOA at 100 yards
INCLUDED	One Mag, Case, Sling, Manual, Warranty

**OPTIONS AND UPGRADES LISTING ON PAGES 10 & 11**

# RRA LAR-15® LE Tactical Carbine

**RRA LAR-15® LE Tactical Carbine**  
.223/5.56mm ..... LE1080

**RRA LAR-15® LE Tactical Carbine SBR Model** ..... LE2080

**RRA LAR-15® LE Tactical Carbine Select Fire Model** . LE9080

*Contact your RRA LE/Gov't Representative for LE Pricing*



**RRA LAR-8® LE**  
**Mid-Length A4**

**STANDARD CONFIGURATION**

CALIBER	.308/7.62x51mm NATO Chamber
LOWER RECEIVER	Forged RRA LAR-8®
UPPER RECEIVER	Forged A4 with Detachable A2 Carry Handle
BARREL	Chrome Lined 16 Inch, 1:10 Twist, Cryo Treated
MUZZLE DEVICE	A2 Flash Hider / 5/8-24 Thread
GAS BLOCK	Gas Block Sight Base with Detachable Front Sight
TRIGGER	Standard Single Stage
PISTOL GRIP	Hogue Rubber Pistol Grip
BUTTSTOCK	RRA 6-Position Tactical CAR Stock
HANDGUARD	Mid-Length Handguard
WEIGHT / LENGTH	8.1 Pounds / 38 Inches
ACCURACY	1.5 MOA at 100 Yards
INCLUDED	One Mag, Case, Sling, Manual, Warranty

OPTIONS AND UPGRADES LISTING ON PAGES 10 & 11



RRA LE Series rifles are available with optional RRA Quad Rails, including the RRA Advanced Half Quad Free Float, pictured below.

**RRA LAR-8® LE**  
**Mid-Length A4** ..... LE1340  
 Contact your RRA LE/Gov't Representative for LE Pricing



**RRA LAR-8® LE**  
**Precision A4**

**RRA LAR-8® LE**  
**Precision A4** ..... LE1380  
 Contact your RRA LE/Gov't Representative for LE Pricing

Uses RRA LAR-8® mags, FAL / Metric mags and L1A1 / Inch mags.

**STANDARD CONFIGURATION**

CALIBER	.308/7.62x51mm NATO Chamber
LOWER RECEIVER	Forged RRA LAR-8®
UPPER RECEIVER	Forged A4 with Forward Assist and Port Door
BARREL	20" Chrome Moly Bull Barrel, Target Crown, 1:10 Twist, Cryo Treated
GAS BLOCK	Light Varmint Gas Block with Sight Rail
TRIGGER	RRA Two Stage Match Trigger
PISTOL GRIP	Hogue Rubber Pistol Grip
BUTTSTOCK	A2 Buttstock
HANDGUARD	RRA Aluminum Free Float Tube
WEIGHT / LENGTH	10.4 Pounds / 40 Inches
ACCURACY	1 MOA at 100 Yards
INCLUDED	One Mag, Case, Sling, Manual, Warranty

OPTIONS AND UPGRADES LISTING ON PAGES 10 & 11





**A MODERN TWIST ON A TIMELESS DESIGN**



**1911**  
**POLY**

*Rock River Arms returns to the 1911 platform with a bold step forward . . . the RRA 1911 Poly. The timeless 1911 design, updated to utilize the most modern of materials.*

**STANDARD CONFIGURATION**

5 Inch 1:16 LH Twist Chrome Moly Barrel

Polymer Frame with a Variety of Options

Polymer Mainspring Housing with a Variety of Options

Steel Frame Insert / Steel Slide

RRA Overmolded Pistol Grips with a Variety of Options

Beavertail Grip Safety / Commander Hammer

Aluminum Speed Trigger

RRA Dovetail Front and Rear Sight

Parkerized Finish / Weight 2.04 Pounds



**RRA 1911 POLY .45 ACP**

**Comes with two 7 Round Mags, Polymer Holster, Polymer Mag Loader, Lock, Fitted Case, and RRA Warranty. Please visit [www.rockriverarms.com](http://www.rockriverarms.com) for additional information and pricing.**

**RRA 1911 POLY™ .45 ACP**



Rock River Arms, Inc.  
1042 Cleveland Road  
Colona, IL 61241

**New for 2013!**



**New RRA LAR-15LH LEF-T® Models!**  
See Pages 7-13



**Rock River Arms, Inc.**  
1042 Cleveland Road, Colona, IL 61241  
Toll Free: 866-980-ROCK (7625)  
Tel: 309-792-5780 / Fax: 309-792-5781  
info@rockriverarms.com / www.rockriverarms.com